

Exposed part for Thermostatic One Box Valve ONE BOX_X10BT030

MODEL **X10BT030**

Exposed part for Thermostatic One Box Valve, with 1-2-3 outlet deviator, Minimum depth of installation: 67 mm, without concealed part - Inox AISI 316L, for items ZA00B030-ZA00B031

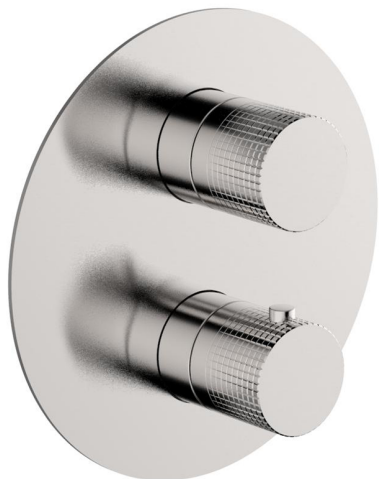

AVAILABLE FINISHINGS

-  **D1** D1 Brushed Inox
-  **5H** 5H Dark Brass Brushed
-  **5L** 5L Brushed Black Titanium
-  **5N** 5N Brushed Rose Gold

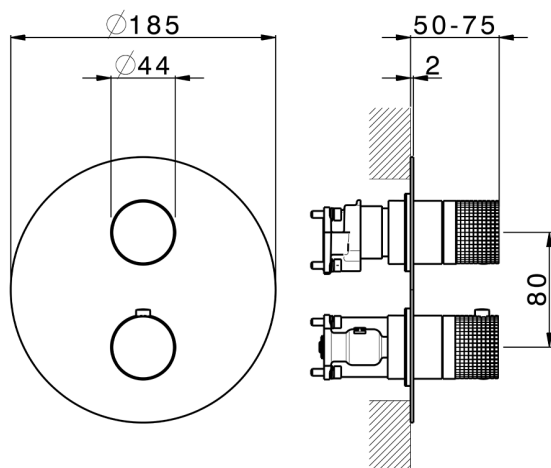

CHARACTERISTICS

Cartridge Spare Parts **24.04A.PP**

8x20 Plus P Thermostatic Valve

Installation **Concealed**

Required concealed parts **ZA00B031**

ZA00B030



DeviaStop

The Cisal Devia Stop technology allows to adjust the water flow and to direct it to the selected output point (overhead soaker, hand shower, etc).



Thermostatic

The Cisal thermostatic is your personal water manager, helping you to handle, control and save water and energy.



Exposed part for Thermostatic One Box Valve ONE BOX_X10BT030

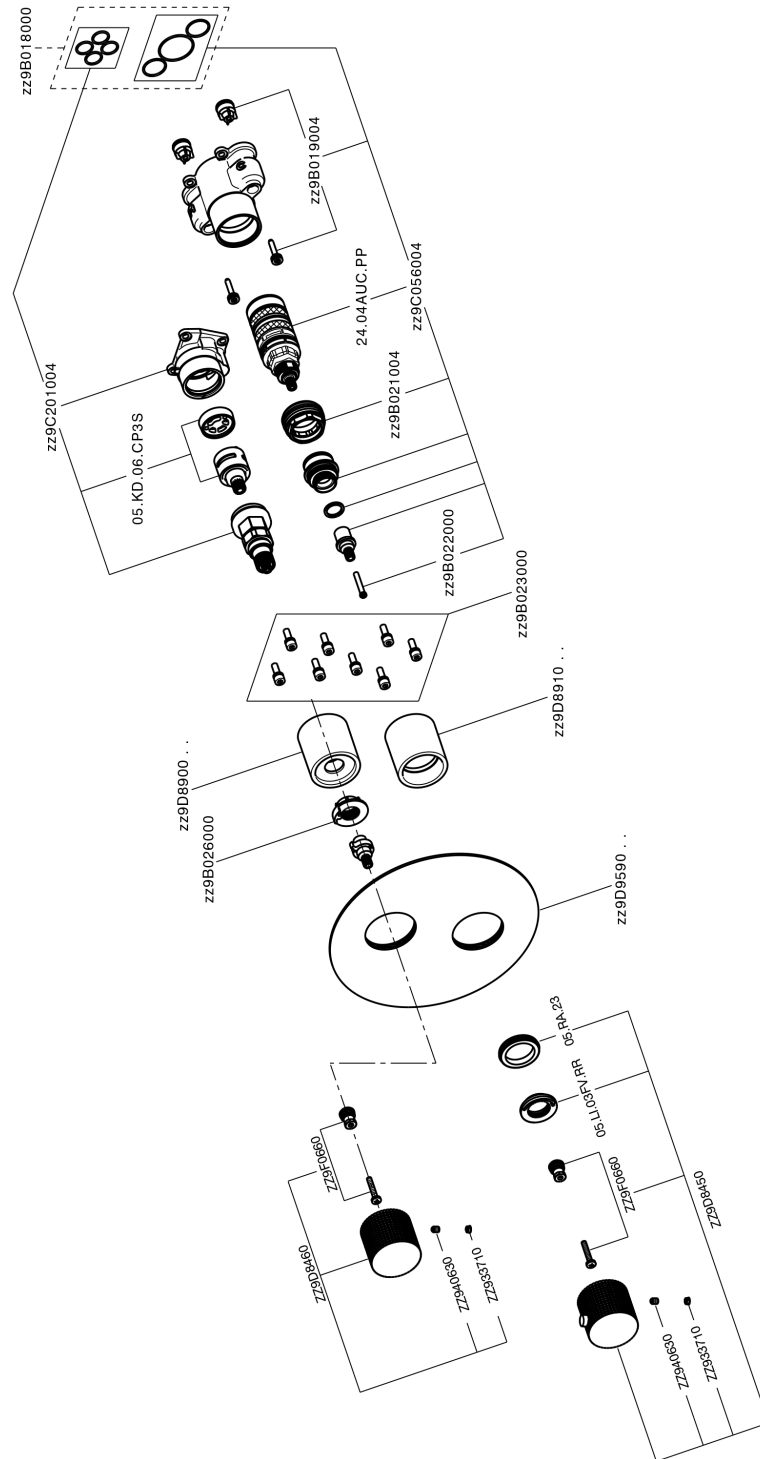

X10BT030

<https://en.cisal.it/exposed-part-for-thermostatic-one-box-valve-one-box-x10bt030>

One Box Universal Concealed Part ONE BOX_ZA00B031

MODEL **ZA00B031**

One Box Universal Concealed Part, for 1, 2 or 3 outlet thermostatic or single lever, without trim kit, with noise reducers, with sealing gasket

AVAILABLE FINISHINGS

 **04** 04 Without finishing

CHARACTERISTICS

Concealed **1**



Thermostatic

The Cisal thermostatic is your personal water manager, helping you to handle, control and save water and energy.



One Box Universal Concealed Part ONE BOX_ZA00B030

MODEL **ZA00B030**

One Box Universal Concealed Part, for 1, 2 or 3 outlet thermostatic or single lever, without trim kit, without noise reducers, with sealing gasket

AVAILABLE FINISHINGS

 **04** 04 Without finishing

CHARACTERISTICS

Concealed **1**



Thermostatic

The Cisal thermostatic is your personal water manager, helping you to handle, control and save water and energy.



2026-04-29