

**Exposed part for Thermostatic One Box Valve ONE BOX\_X10BT030**

X10BT030

<https://en.cisal.it/exposed-part-for-thermostatic-one-box-valve-one-box-x10bt030>

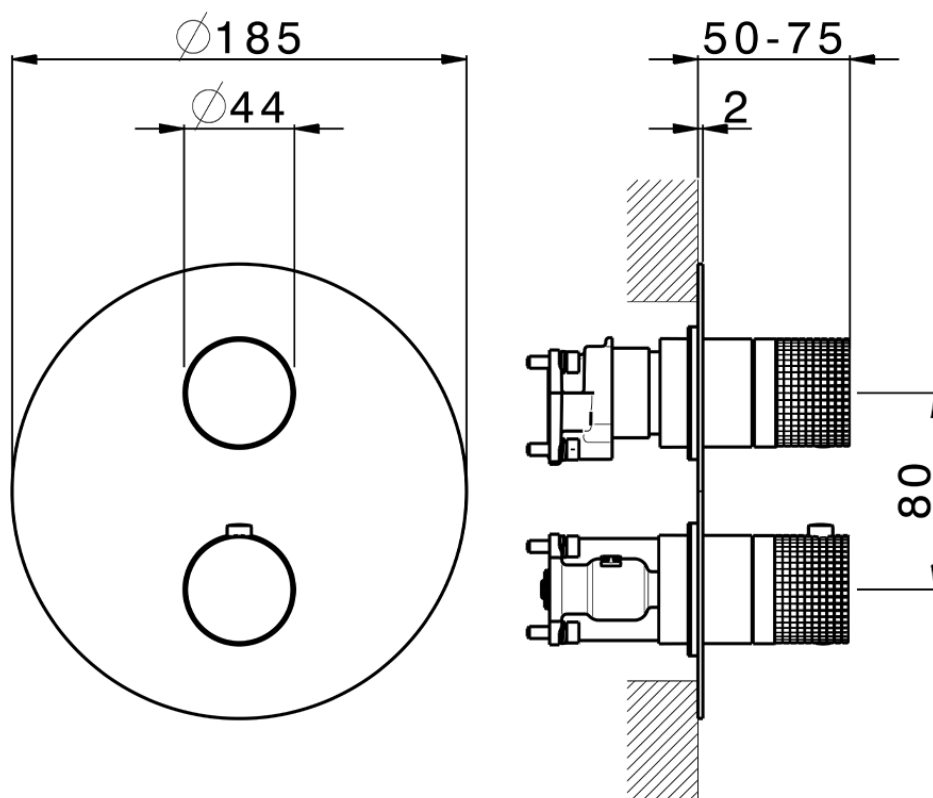

ZA00B031

<https://en.cisal.it/one-box-universal-concealed-part-one-box-za00b031>



ZA00B030

<https://en.cisal.it/one-box-universal-concealed-part-one-box-za00b030>

2026-04-28