

3 Function thermostatic concealed valve PUSH&SHOWER_ZA0G63R0

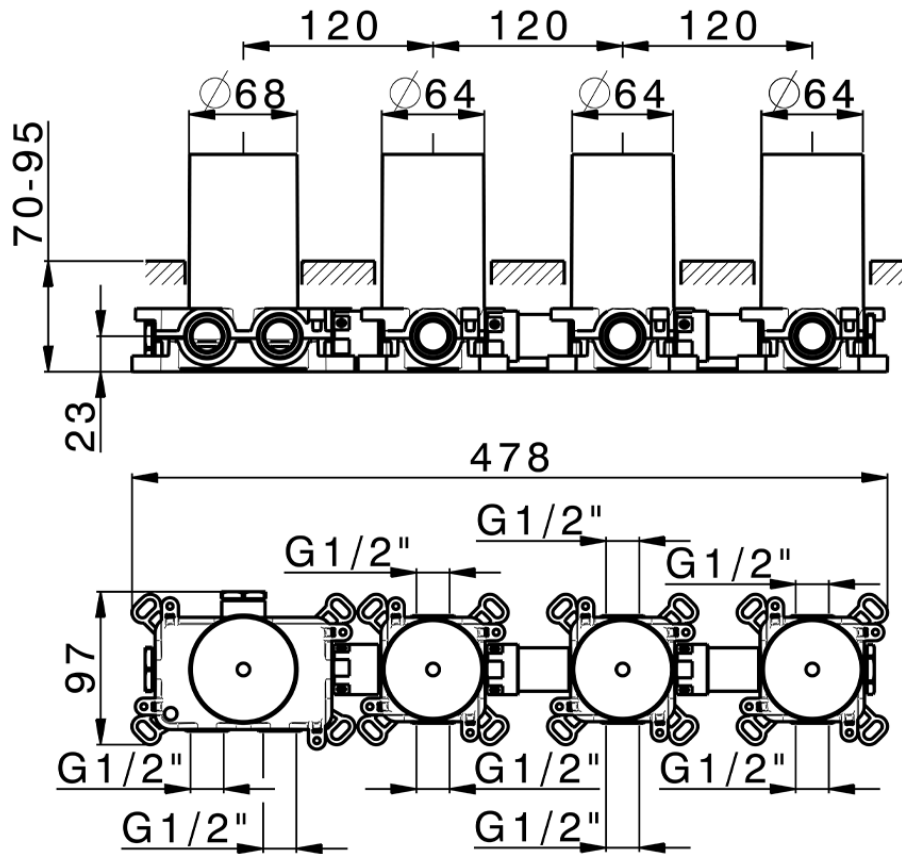

ZA0G63R0

<https://en.cisal.it/3-function-thermostatic-concealed-valve-pushshower-za0g63r0>

2026-04-28