

Concealed rapid flow valve COMPONENTS_ZA002711

MODEL **ZA002711**

Concealed rapid flow valve, G.1" outlet

AVAILABLE FINISHINGS



CHARACTERISTICS

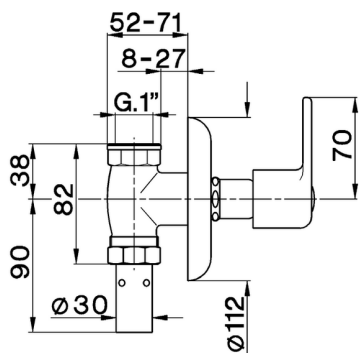

2026-04-04