



Bath mixer, full equipment BARCELONA_BA000090

MODEL **BA000090**

Bath mixer, full equipment, with deck mount
pillars, Brass minimalistic one spray handshower, 150
cm PVC Flexible Hose



AVAILABLE FINISHINGS

-  **21** 21 Chrome
-  **2A** 2A Satin Brushed Nickel
-  **40** 40 Matt Black

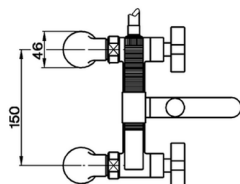
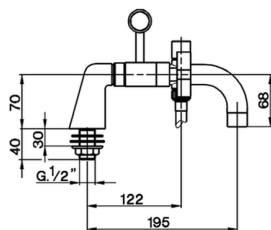

CHARACTERISTICS



Bath mixer, full equipment BARCELONA_BA000090

cisal

BA 00009

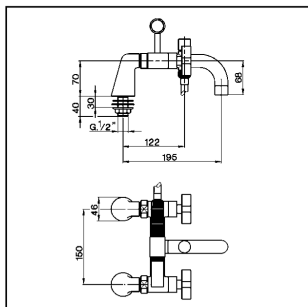

- Gruppo vasca a squadra
- Deck mounted bath mixer
- Badebatterie
- Mélangeur bain/douche sur gorge

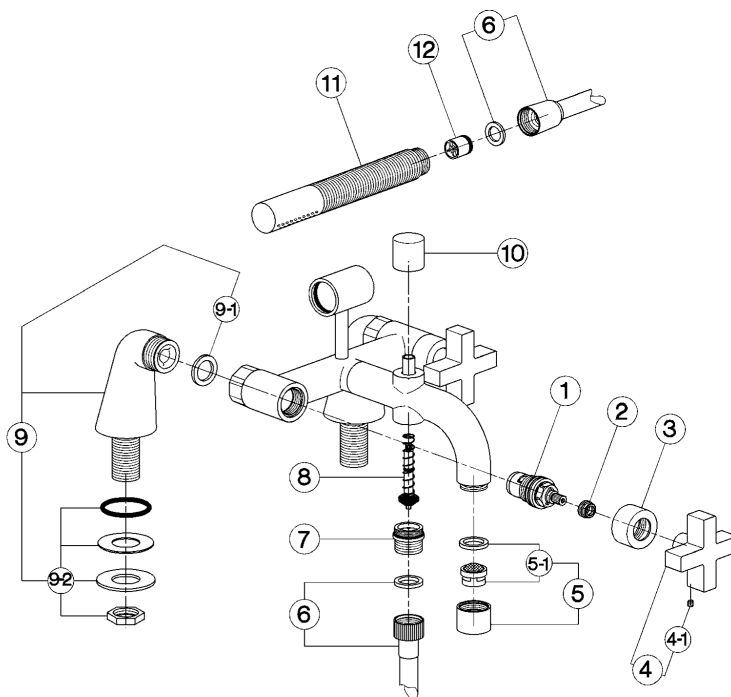

bar	PORTATA BOCCA DI EROGAZIONE * SPOUT FLOW RATE DURCHFLUSS WANNENEINLAUF DEBIT BEC DEVERSEUR l/min.
0,5	10
1	14
2	20
3	25
4	28,5
5	32

* con resistenza silenziosa della classe di portata C (30 l/min. a 3 bar)
with hydraulic resistance of flow rate class C (30 l/min. at 3 bar)
mit geräuscharmen Widerstand der Durchflussklasse C (30 l/min. bei 3 bar)
avec aérateur classe C (30 l/min. à 3 bar)

NR.	DESCRIZIONE DESCRIPTION BESCHREIBUNG DESCRIPTION	N. CODICE CODE NO. WERKSNR. NR. CODE	NR.	DESCRIZIONE DESCRIPTION BESCHREIBUNG DESCRIPTION	N. CODICE CODE NO. WERKSNR. NR. CODE	NR.	DESCRIZIONE DESCRIPTION BESCHREIBUNG DESCRIPTION	N. CODICE CODE NO. WERKSNR. NR. CODE
1	Vitone ceramico 1/2" DX 90° Ceramic headvalve 1/2" right 90° Keramikoberteil 1/2" - rechts - 90° Tête céram. 1/2" droite 90°	ZZ 92907 0	5-1	Cartuccia per aereatore M. 22x1 Cascade Mousseur cartridge M.22x1 Cascade Kar. 1/Perlator M.22x1 Cascade Cartouche x mousseur M.22x1 Cascade	ZZ 93318 0	9-2	Set installazione raccordo verticale Installation set for vertical connection Belegungsset Stand-Anschluss-Ventil Set installation	ZZ 92984 0
2	Riduzione brocciata completa Complete broached reduction piece Verkürzung Raemwerkzeug komplett Reduction avec brochage complète	ZZ 93330 0	6	Flex PVC 150 cm Ø14 1/2"x1/2" conico Brauseschl. PVC 150 cm Ø14 1/2"x1/2" Flex.PVC 150 cm Ø14 1/2"x1/2"	ZZ 93304 0	10	Pomolo per deviazione Knob for diverter Zugknopf Umsteller Pommeau pour inverseur	ZZ 93329 0
3	Cappuccio cognivitone "BA" Escutcheon "BA" Abdeckklappe "BA" Rosace couvre-tête "BA"	ZZ 93327 0	7	Attacco flessibile Flexible connection Flex Anschluss Raccord flex	ZZ 93554 0	11	Doccia minimale Minimal handshower Handbrause minimal Douchette minimal	DS 01409 0
4	Maniglia "BA" per monolori Handle "BA" for single hole mixer Griff "BA" 1/Einloch-Batterien Croisillon "BA" pour mélangeur monolori	ZZ 93289 0	8	Asta deviazione completa Complete diverting rod Umstellung Tige inverseur complète	ZZ 93314 0	12	Valvola anti-ritorno Ø15 per doccia Back-flow valve Ø15 Durchflussverhinderer Ø15 Clapet anti-retour Ø15	ZZ 92956 0
4-1	Grano punta piana inox M.4x4 Screw-stainless steel M.4x4 Mädenschraube M 4x4 Vis speciale inox M.4x4	ZZ 93328 0	9	Raccordo verticale fisso G.1/2" Vertical connection G.1/2" Stand-Anschluss G.1/2" Colonnettes G.1/2"	ZA 00379 0			
5	Aeratore M.22x1 IC Cascade Mousseur M.22x1 IC Cascade Perlator M.22x1 IC Cascade Mousseur M.22x1 IC Cascade	ZZ 93284 0	9-1	Guarnizione NBR 90 SH. 24x16x2,7 Gasket NBR 90 SH. 24x16x2,7 Dichtung NBR 90 SH. 24x16x2,7 Joint NBR 90 SH. 24x16x2,7	ZZ 92689 0			

BA.1

BA000090

<https://en.cisal.it/bath-mixer-full-equipment-barcelona-ba000090>

2026-06-25