





## Cover Part for 3 Function Concealed Thermo. Valve WELLNESS\_SM01R300

MODEL **SM01R300**

Cover Part for 3 Function Concealed Thermo.Valve,for item ZA01R300

### AVAILABLE FINISHINGS

-  **21** 21 Chrome
-  **2B** 2B Polished Nickel
-  **40** 40 Matt Black
-  **4Q** 4Q Matt White

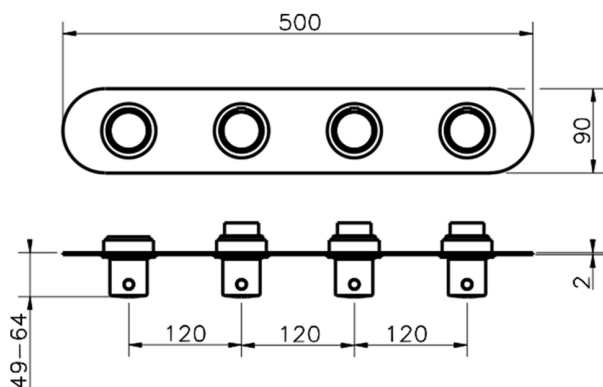
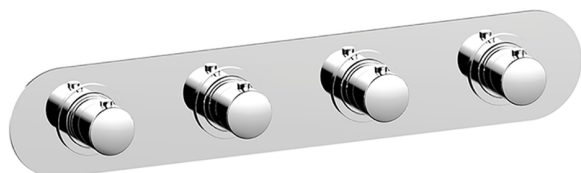

### CHARACTERISTICS

Installation **Concealed**  
 Required concealed parts **ZA01R300**



### Thermostatic

The Cisal thermostatic is your personal water manager, helping you to handle, control and save water and energy.



## 3 Function Concealed Thermostatic Built-in Part CONCEALED\_ZA01R300

MODEL **ZA01R300**

3 Function Concealed Thermostatic Built-in Part

AVAILABLE FINISHINGS

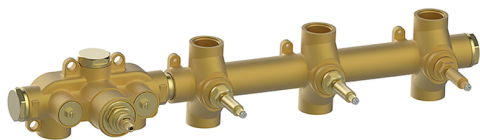

CHARACTERISTICS

Concealed **1**  
 Cartridge Spare Parts **23.51A.HF**  
**HF Thermostatic Valve**

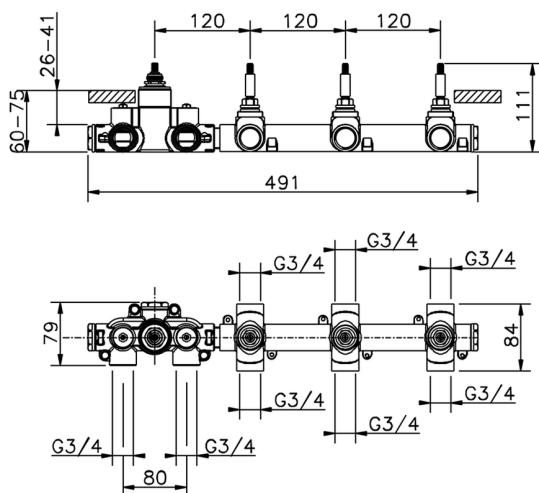

### Thermostatic

The Cisal thermostatic is your personal water manager, helping you to handle, control and save water and energy.



2025-01-05