

**2 Function thermostatic concealed valve PUSH&SHOWER\_ZA0G62R0**

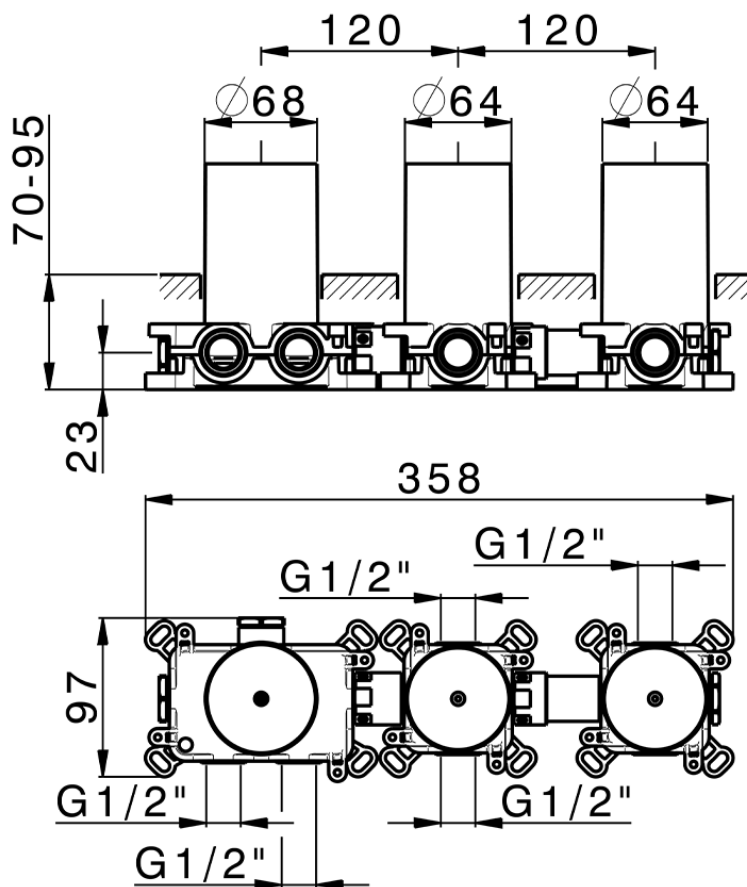

ZA0G62R0

<https://en.cisal.it/2-function-thermostatic-concealed-valve-pushshower-za0g62r0>

2026-04-28