

## Spout COMPONENTS\_ZA001252

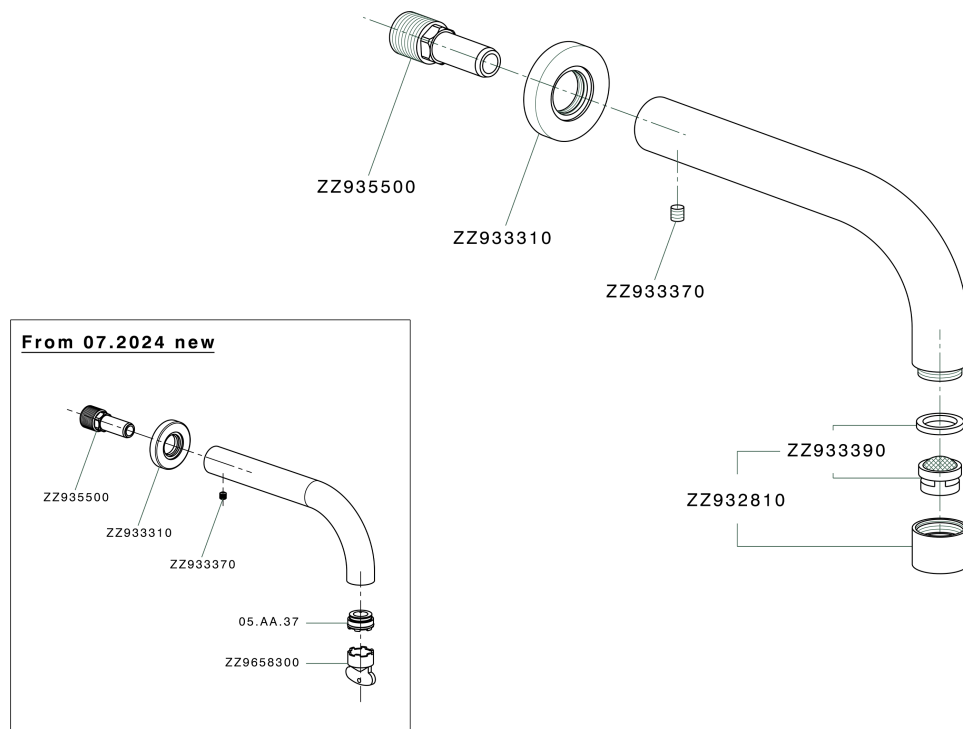

ZA001252

<https://en.cisal.it/spout-components-za001252>

2025-01-06