

Thermostatic shower column, 2-functions ARCANA CERAMIC_AC004080

cisal

AC 00408 0

da Febbraio 2009 - from February 2009
ab Februar 2009 - de Février 2009

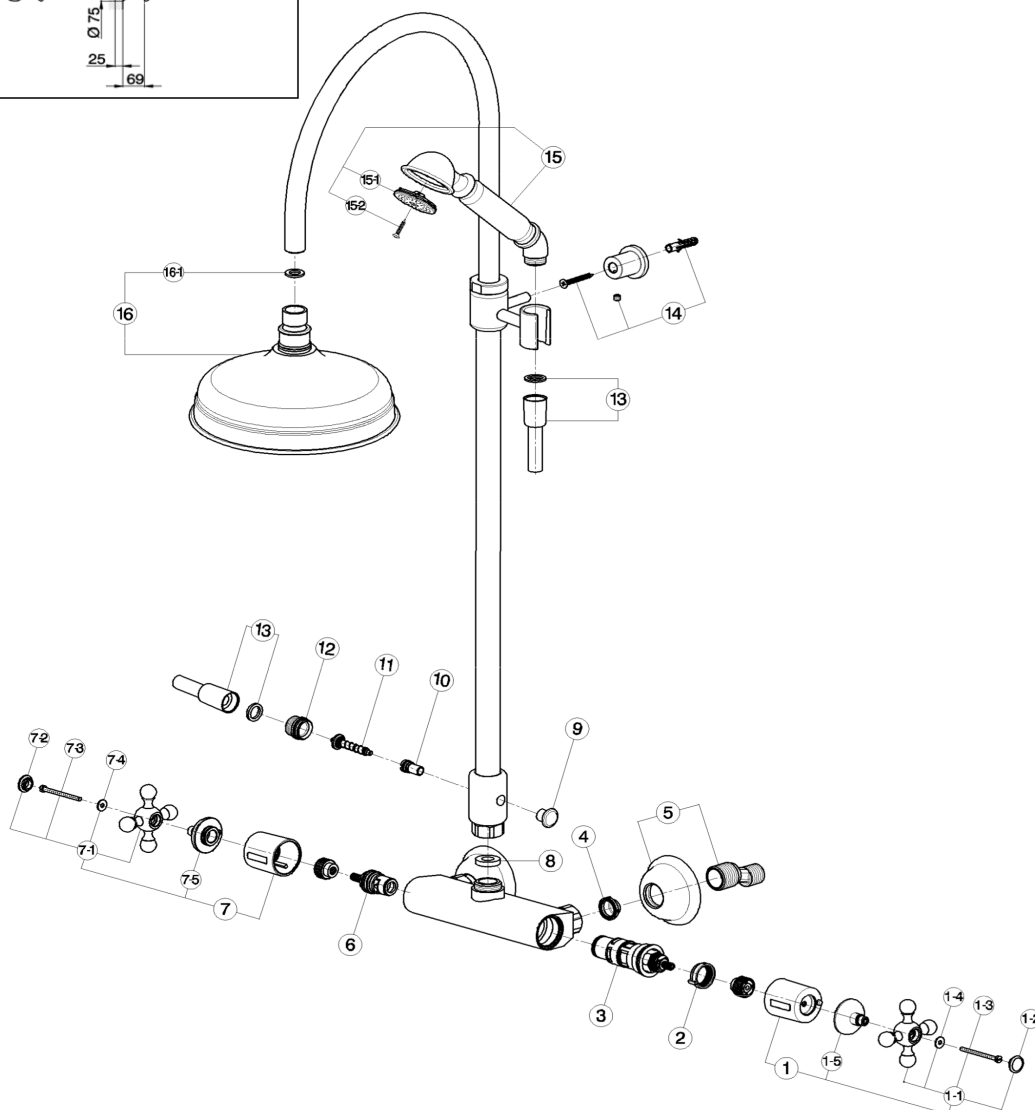
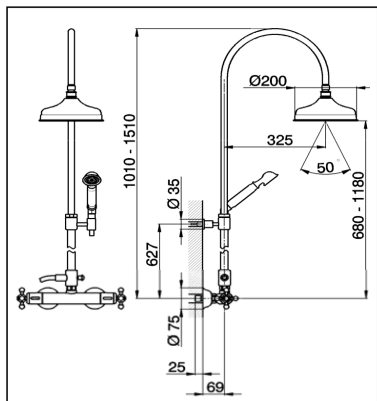

AC004080

<https://en.cisal.it/thermostatic-shower-column-2-functions-arcana-ceramic-ac004080>

Thermostatic shower column, 2-functions ARCANA CERAMIC_AC004080

cisal

AC 00408 0

 da Febbraio 2009 - from February 2009
 ab Februar 2009 - de Février 2009

NR.	DESCRIZIONE DESCRIPTION BESCREIBUNG DESCRIPTION	N.CODICE CODE NO. WERSKNR. NR.CODE	NR.	DESCRIZIONE DESCRIPTION BESCREIBUNG DESCRIPTION	N.CODICE CODE NO. WERSKNR. NR.CODE	NR.	DESCRIZIONE DESCRIPTION BESCREIBUNG DESCRIPTION	N.CODICE CODE NO. WERSKNR. NR.CODE
1	Maniglia "AC" regolazione temperatura Croisillon "AC" gradué Handle - temperature set-up "AC" Griff "AC" Temperaturbergrenzer	ZZ946050	6	Vitone ceramico 1/2 destro 180° term. Tête céramique 1/2 droite 180° therm. Ceramic headvalve 1/2 right 180° therm. Keramikoberteil 1/2 rechts 180°Therm.	ZZ945890	11	Asta deviazione completa Tige inverseur complète Complete diverting rod Umstellung	ZZ933140
1-1	Piastra deviatore ceramico 4 vie Plaque pour inverseur céram. 4 voies Plate for 4 ways ceramic diverter Abdeckrosette fuer 4 Wege Keramik.	ZZ936870	7	Maniglia HA regolazione portata Croisillon HA debit Handle - flow rate control HA Griff HA fuer Absperrung	ZZ935860	12	Attacco flessibile Raccord flex Flexible connection Flex Anschluss	ZZ931410
1-2	Placchetta a vite maniglia AR Plaquette cache vis croisillon AR Cap for handle AR Abdeckkappe AR Griff	ZZ926170	7-1	Maniglia HA con vite e placchetta Croisillon avec vis et plaquette HA Handle with scre and plate HA Griff HA mit Schraube und Abdeckkap.	ZZ935870	13	Flessibile D.14x150 1/2" conico x 1/2" Flexible D.14x150 avec raccord 1/2" Hose D.14x150 1/2"x1/2" Schlauch D.14x150 1/2" Konus x 1/2"	ZA009030
1-3	Vite M.4x47 Vis M. 4x27 Screw M. 4x27 Schraube M.4x27	ZZ935630	7-2	Placchetta a vite maniglia AR Plaquette cache vis croisillon AR Cap for handle AR Abdeckkappe AR Griff	ZZ926170	14	Set installazione asta doccia Set installation colonne de douche Installation set for sliding bar Installationsset für Wandstange	ZZ949870
1-4	Rondella ottone 12x4,3x1 Joint laiton 12x4,3x1 Ring in brass 12x4,3x1 Unterlegscheibe 12x4,3x1	ZZ926730	7-3	Vite M.4x47 Vis M. 4x27 Screw M. 4x27 Schraube M.4x27	ZZ935630	15	Doccia Arcana Douchette Arcana Arcana handshower Handbrause Arcana	DS014110
1-5	Placchetta maniglia "AC" per thermost. Plaquette croisillon "AC" pour thermost. Cap "AC" handle for thermost. mixer Abdeckkappe Griff "AC" f.Thermost. Ghiera limitatrice di temperatura "H2"	ZZ946060	7-4	Rondella ottone 12x4,3x1 Joint laiton 12x4,3x1 Ring in brass 12x4,3x1 Unterlegscheibe 12x4,3x1 Placchetta maniglia "AC" per thermost.	ZZ926730	15-1	Vite di fissaggio diffusore per doccia Vis de fixation diffuseur pour douchette Fixing screw for spray kit handshower Befestigungsschraube fuer Einsatz Diffusore doccia AR	ZZ934010
2	Ecroi - limiteur temperat. "H2" Nut - temperature device "H2" Temperaturbrgr-ring "H2"	ZZ945840	7-5	Placchetta croisillon "AC" pour thermost. Cap "AC" handle for thermost. mixer Abdeckkappe Griff "AC" f.Thermost.	ZZ9460600	15-2	Aeratore doccia AR Aerator for showers AR Zerstaeuber fuer Brause AR	ZZ905440
3	Cartuccia termostatico H2 Cartouche thermostatique H2 Thermostatic mixing valve H2 Thermoelement H2 Guarnizione G.3/4" con filtro	ZZ945860	8	Guarnizione NBR 90 SH. 24x16x2,7 Joint NBR 90 SH. 24x16x2,7 Gasket NBR 90 SH. 24x16x2,7 Dichtung NBR 90 SH. 24x16x2,7 Pomolo per deviazione	ZZ926890	16	Soffione doccia Pomme de douche Headshower Kopfbrause Guarnizione fibra 18,5x11x2	DS016140
4	Joint avec filtre Gasket with filter Dichtung G.3/4" mit Filter	ZZ945870	9	Pommeau pour inverseur Knob for diverter Zugknopf Umsteller Corpo deviazione automatica	ZZ933940	16-1	Joint en fibre 18,5x11x2 Gasket rubber 18,5x11x2 Fiberdichtung 18,5x11x2	ZZ927140
5	Eccentrico con rosone "AC" per thermost. Excentrique + rosace "AC" Excentric connection with escutch."AC" S - Anschluss m.Rosette "AC"	ZZ946070	10	Corpo deviazione automatica Corps inverseur automatique Body for automatic diverter Körper für automatische Umstellung	ZZ949860			

AC004080

<https://en.cisal.it/thermostatic-shower-column-2-functions-arcana-ceramic-ac004080>

2026-04-10