

## Floor pillar legs COMPONENTS\_ZA003830

MODEL **ZA003830**

Floor pillar legs

AVAILABLE FINISHINGS

-  **21** 21 Chrome
-  **24** 24 Gold
-  **26** 26 Old Copper
-  **27** 27 Old Bronze
-  **2A** 2A Satin Brushed Nickel

CHARACTERISTICS

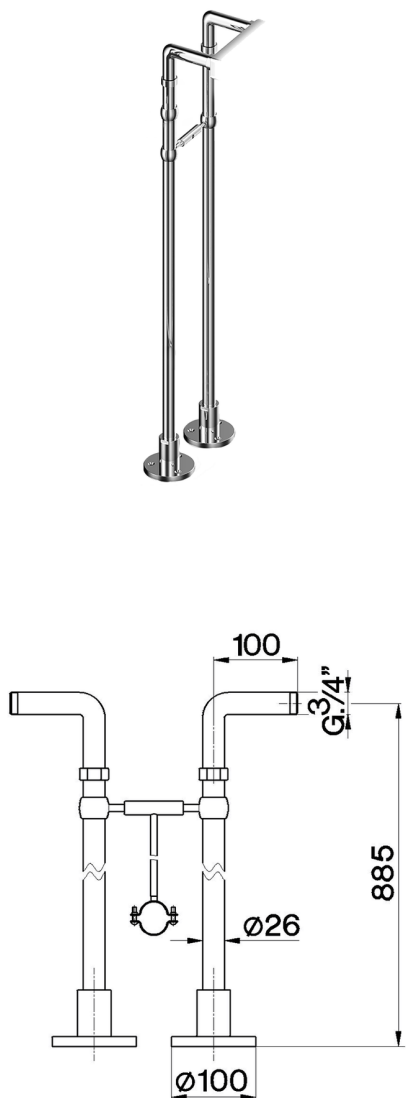

## Floor pillar legs COMPONENTS\_ZA003830

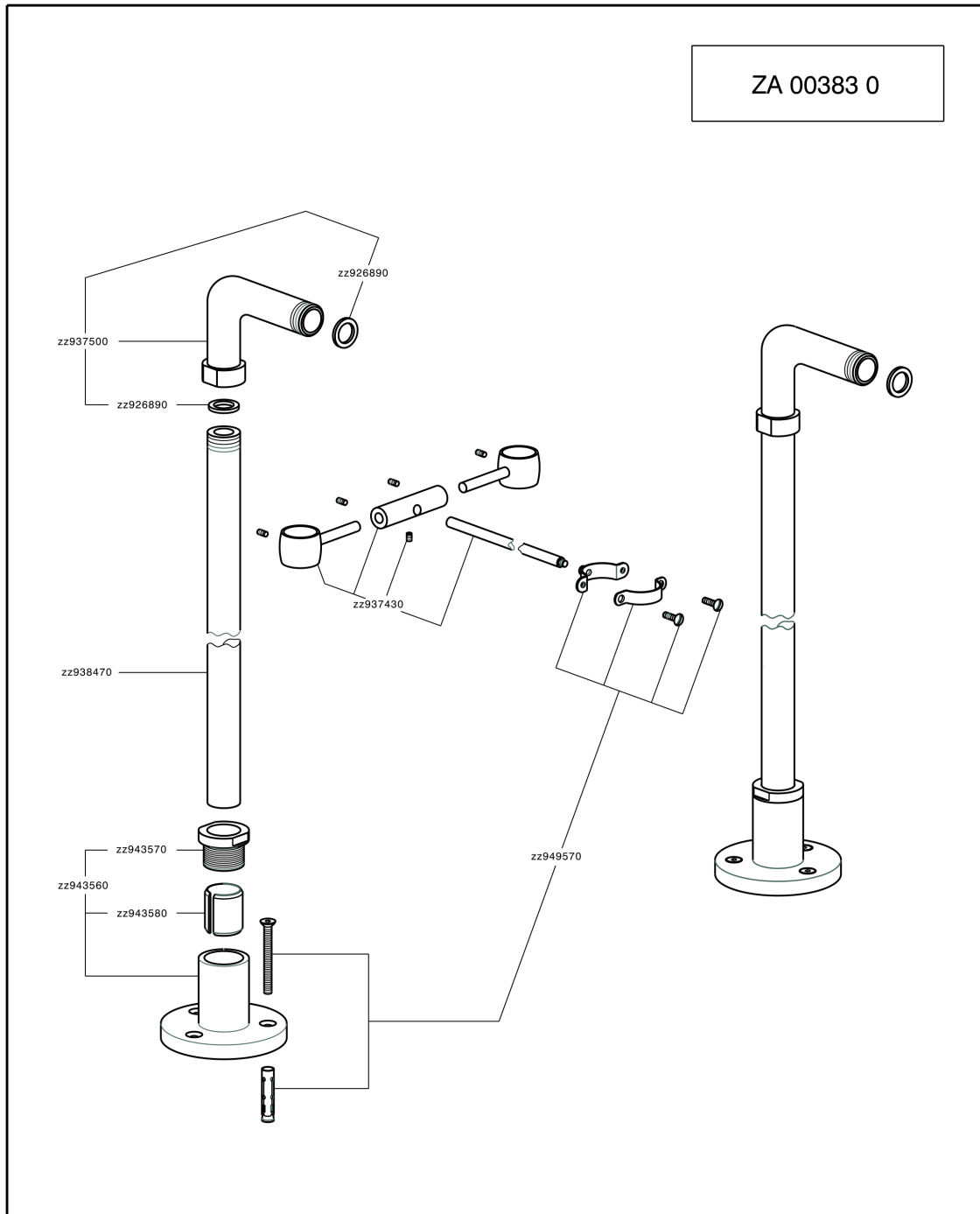

**cisal**  
RUBINETTERIA

Rubineria CISAL S.p.A.  
Via P. Durio, 160  
28010 Alzo di Pella (Novara) - Italia  
Tel. +39 0322 918111  
Fax +39 0322 269919  
E-mail: [cisal@cisal.it](mailto:cisal@cisal.it) - [www.cisal.it](http://www.cisal.it)

CISAL Sanitär Armaturen Vertriebs GmbH  
Gewerbstrasse, 6  
91452 Wilhelmsdorf - Deutschland  
Tel. +49 09102 9382-0  
Fax +49 09102 9382-92  
E-mail: [info@cisal.de](mailto:info@cisal.de) - [www.cisal.de](http://www.cisal.de)

### ACCESSORI - art. ZA 00383 0

- Colonne da pavimento
- Floor column connections
- Raccords colonnettes au sol
- Standsaeule
- Columnas de suelo

19.06.12

ZA003830

<https://en.cisal.it/floor-pillar-legs-components-za003830>

2026-06-10