

Floor pillar legs COMPONENTS_ZA003830

MODEL **ZA003830**

Floor pillar legs

AVAILABLE FINISHINGS

-  **21** 21 Chrome
-  **24** 24 Gold
-  **26** 26 Old Copper
-  **27** 27 Old Bronze
-  **2A** 2A Satin Brushed Nickel

CHARACTERISTICS

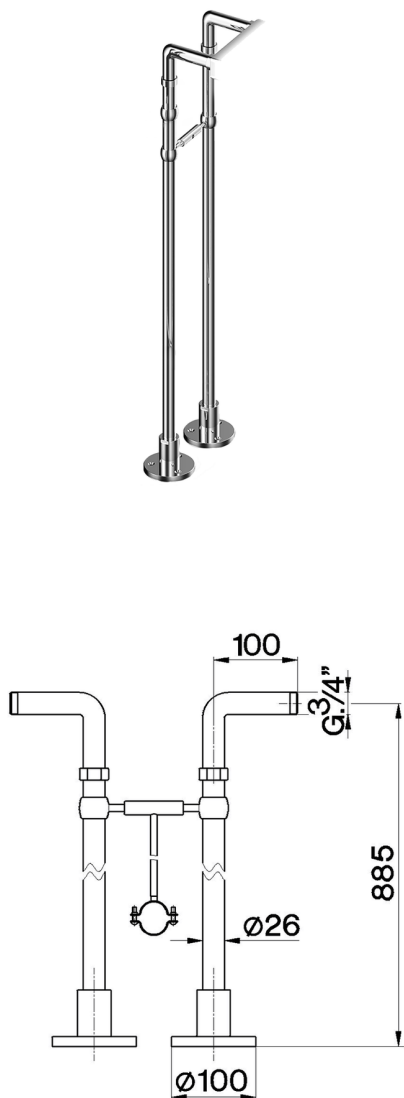

Floor pillar legs COMPONENTS_ZA003830

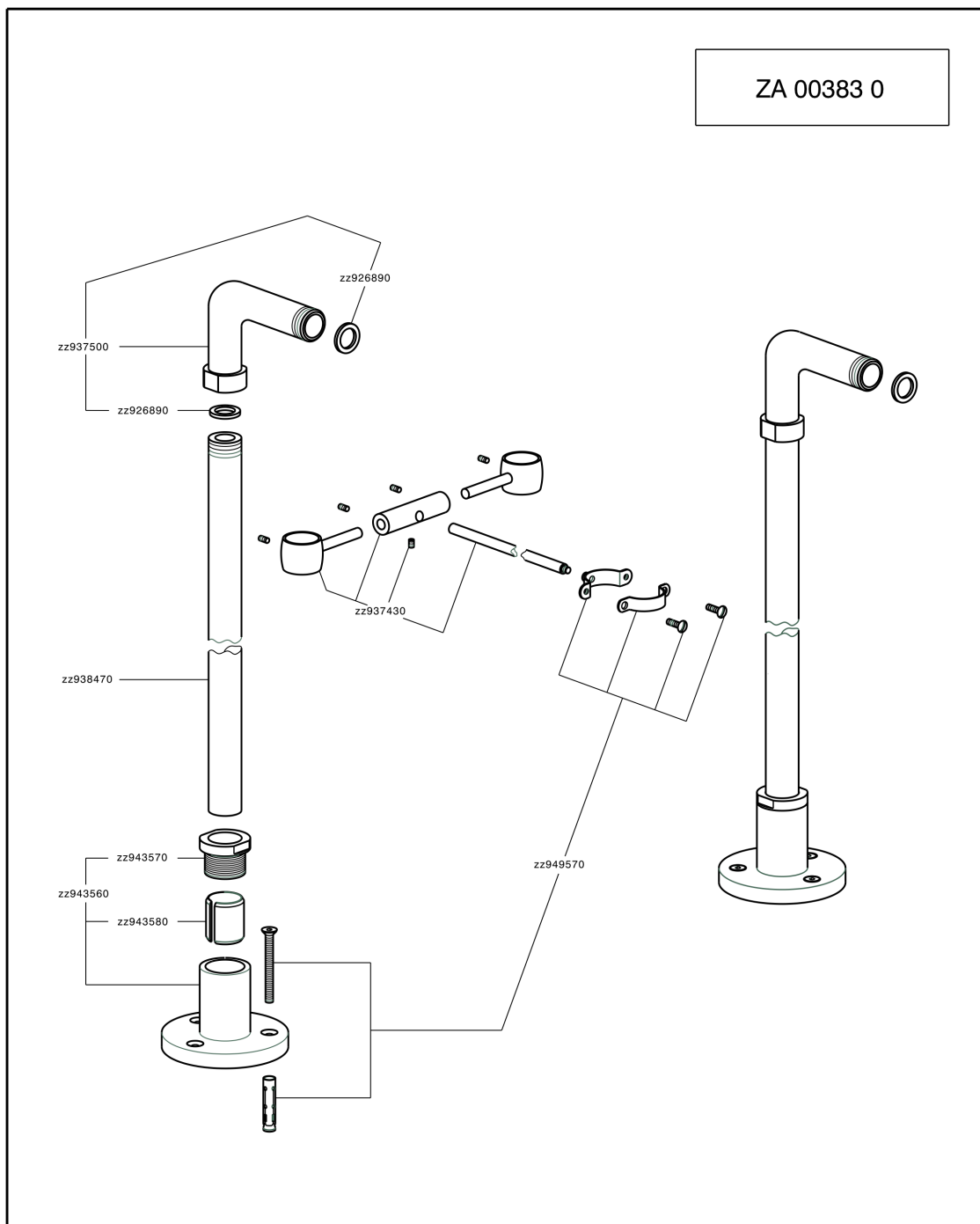

ZA 00383 0



cisal
RUBINETTERIA

Rubineria CISAL S.p.A.
Via P. Durio, 160
28010 Alzo di Pella (Novara) - Italia
Tel. +39 0322 918111
Fax +39 0322 269919
E-mail: cisal@cisal.it - www.cisal.it

CISAL Sanitär Armaturen Vertriebs GmbH
Gewerbstrasse, 6
91452 Wilhelmsdorf - Deutschland
Tel. +49 09102 9382-0
Fax +49 09102 9382-92
E-mail: info@cisal.de - www.cisal.de

ACCESSORI - art. ZA 00383 0

- Colonne da pavimento
- Floor column connections
- Raccords colonnettes au sol
- Standsaeule
- Columnas de suelo

19.06.12

ZA003830

<https://en.cisal.it/floor-pillar-legs-components-za003830>

2026-05-17