

Exposed sink mixer TR_TR000410

cisal

TR 00041 (TR 00043)

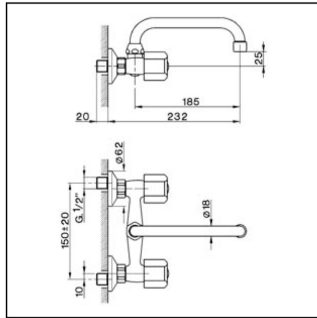

- Gruppo lavello
- Sink mixer
- Spültisch-Wandbatterie
- Mélangeur évier mural

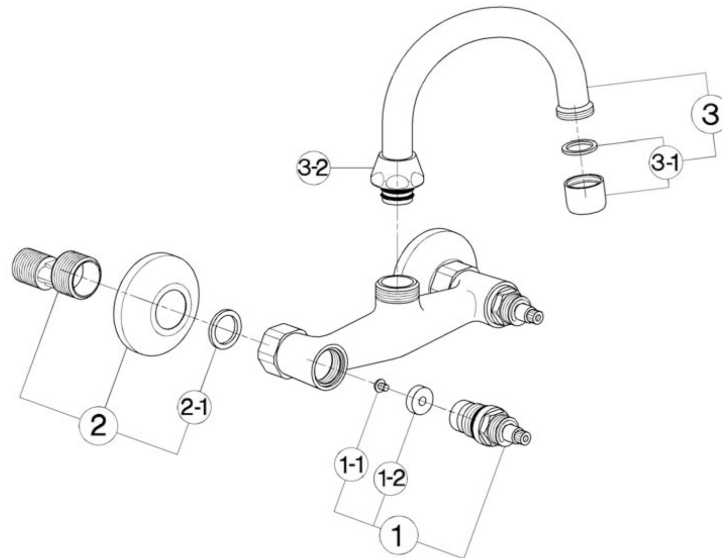
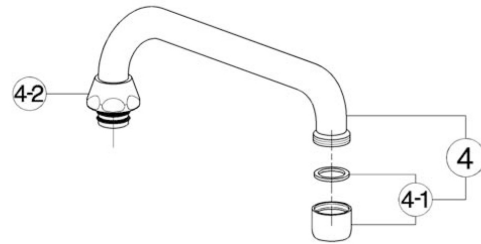

bar	PORTATA BOCCA DI EROGAZIONE * SPOUT FLOW RATE DURCHFLOSS WANNENEINLAUF DEBIT BEC DÉVERSEUR l/min.
0.1	20.5
0.2	27.5
0.3	36
0.4	41.5
0.5	46.5
1	66

* con rompigetto
with antispash
mit Strahlregler
avec brise-jet

NR.	DESCRIZIONE DESCRIPTION BESCHREIBUNG DESCRIPTION	N. CODICE CODE NO. WERKSNR. NR. CODE	NR.	DESCRIZIONE DESCRIPTION BESCHREIBUNG DESCRIPTION	N. CODICE CODE NO. WERKSNR. NR. CODE	NR.	DESCRIZIONE DESCRIPTION BESCHREIBUNG DESCRIPTION	N. CODICE CODE NO. WERKSNR. NR. CODE
1	Vitone 1/2" "TR" Headvalve 1/2" "TR" Oberteil 1/2" "TR" Tête 1/2" "TR"	ZZ 92869 0	3-1	Rompigetto M.22x1 Antispash M.22x1 Strahlregler M.22x1 Brise-jet M.22x1	ZZ 92771 0			
1-1	Vite M.4x4.5 tb. Ø8 t.cr. Screw M.4x4.5 Schraube M.4x4.5 Vis M.4x4.5	ZZ 92625 0	3-2	Calotta 3/4" es.29 Ø19.5 Nut 3/4" Ø19.5 Mutter 3/4" Ø19.5 Ecrrou 3/4" Ø19.5	ZZ 92615 0			
1-2	Guarnizione NBR 90 SH. 16.9x5.5x5 Gasket NBR 90 SH. 16.9x5.5x5 Dichtung NBR 90 SH. 16.9x5.5x5 Joint NBR 90 SH. 16.9x5.5x5	ZZ 92699 0	4	Canna a U Ø18 interasse 185 Swinging spout 185 Ø18 Auslauf-Rohr-U-185 Ø18 Bec orientable 185 Ø18	ZZ 92736 0			
2	Eccentrico con rosone Excentric connection with escutcheon S - Anschluss m. Rosette Excentrique + rosace	ZZ 92730 0		Rompigetto M.22x1 Antispash M.22x1 Strahlregler M.22x1 Brise-jet M.22x1	ZZ 92771 0			
2-1	Guarnizione NBR 90 SH. 24x16x2.7 Gasket NBR 90 SH. 24x16x2.7 Dichtung NBR 90 SH. 24x16x2.7 Joint NBR 90 SH. 24x16x2.7	ZZ 92689 0	4-2	Calotta 3/4" es.29 Ø19.5 Nut 3/4" Ø19.5 Mutter 3/4" Ø19.5 Ecrrou 3/4" Ø19.5	ZZ 92615 0			
3	Canna alta Ø18 interasse 155 Swinging spout 155 Ø18 Auslauf-Rohr-U-155 Ø18 Bec orientable 155 Ø18	ZZ 92737 0						

TR000410

<https://en.cisal.it/exposed-sink-mixer-tr-tr000410>

2026-06-13