

## Exposed part for con.thermo.shower mixer, 3-outlet WAVE\_WE019200

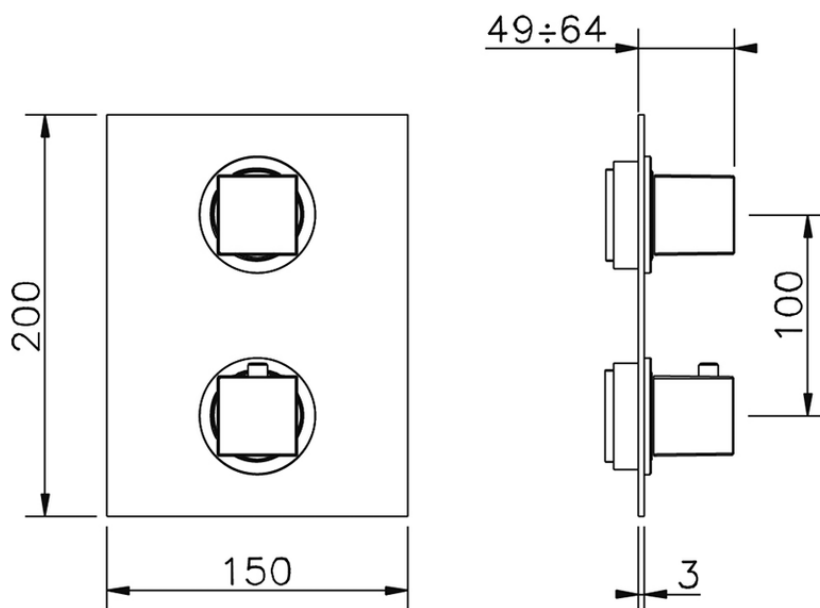

WE019200

<https://en.cisal.it/exposed-part-for-con-thermo-shower-mixer-3-outlet-wave-we019200>

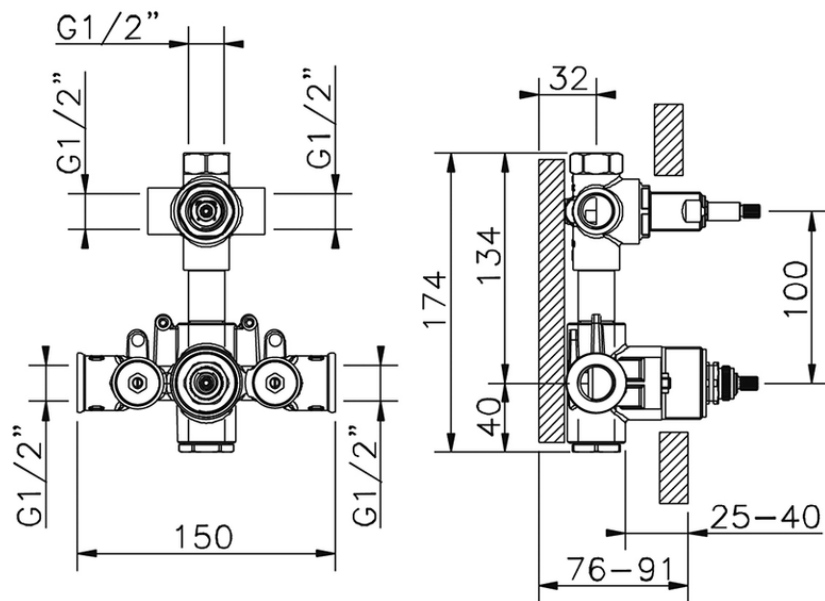

ZA019201

<https://en.cisal.it/concealed-thermostatic-shower-mixer-3-outlets-concealed-za019201>

2026-06-26