

Glass holder BATHROOM ACCESSORIES_SY090501

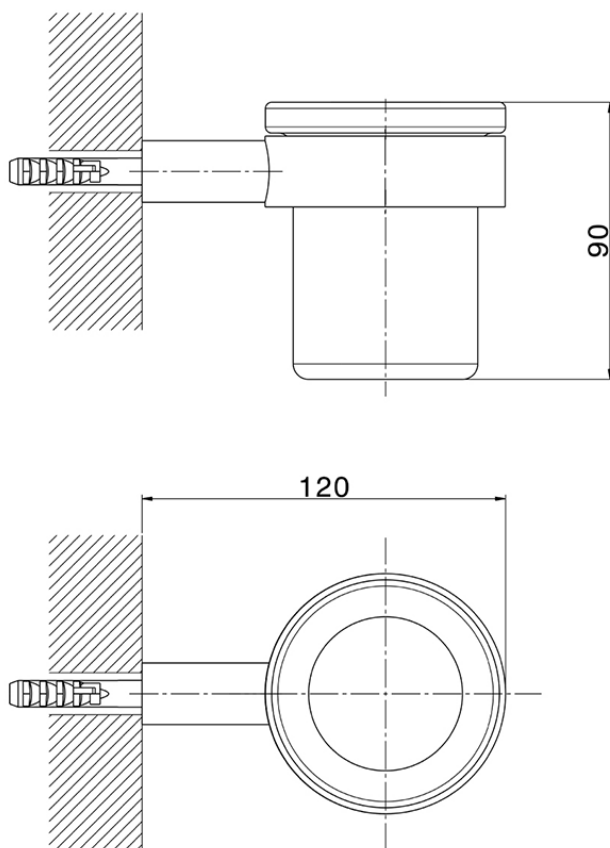

SY090501

<https://en.cisal.it/glass-holder-bathroom-accessories-sy090501>

2026-04-26