

Temperature Limiter ARCANA COMPONENTS_AR001460

cisal

AR 00146

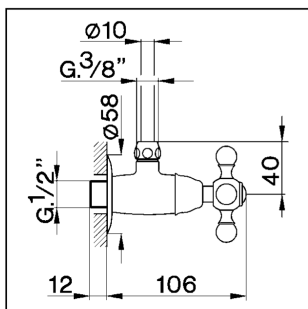

- Rubinetto di alimentazione
- Angle supply
- Eckventil
- Robinet d'alimentation

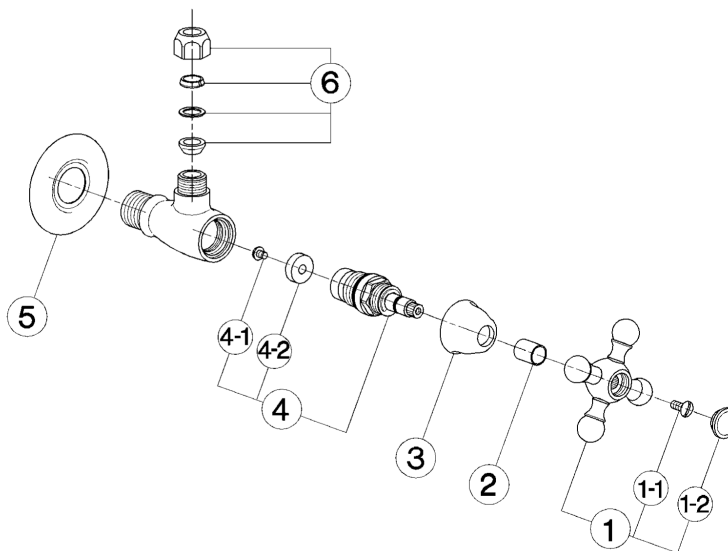

bar	PORTATA * FLOW RATE DURCHFLOSS DEBIT l/min.
0.1	9.5
0.3	15.5
0.5	19.5
1	27
2	37.5
3	45.5

* senza resistenza silenziosa (uscita libera)
without hydraulic resistance
ohne Widerstand
sans résistance hydraulique

NR.	DESCRIZIONE DESCRIPTION BESCHREIBUNG DESCRIPTION	N. CODICE CODE NO. WERKSNR. NR. CODE	NR.	DESCRIZIONE DESCRIPTION BESCHREIBUNG DESCRIPTION	N. CODICE CODE NO. WERKSNR. NR. CODE	NR.	DESCRIZIONE DESCRIPTION BESCHREIBUNG DESCRIPTION	N. CODICE CODE NO. WERKSNR. NR. CODE
1	Maniglia "AR" con vite e placchetta Handle with screw and plate "AR" Griff "AR" mit Schraube und Abdeckkappe Crosillon avec vis et plaque "AR"	ZZ 90307 0	4-1	Vite M.4x4,5 lb. Ø8 l.c. Screw M.4x4,5 Schraube M.4x4,5 Vis M.4x4,5	ZZ 92625 0			
1-1	Vite M.4,5x10 lb. tc. zigrinata Screw M.4,5x10 Schraube M.4,5x10 Vis M.4,5x10	ZZ 92609 0	4-2	Guarnizione NBR 90 SH. 16,9x5,5x5 Gasket NBR 90 SH. 16,9x5,5x5 Dichtung NBR 90 SH. 16,9x5,5x5 Joint NBR 90 SH. 16,9x5,5x5	ZZ 92699 0			
1-2	Placchetta a vite maniglia "AR" Cap for handle "AR" Abdeckkappe "AR" Griff Plaque cache - vis crois. "AR"	ZZ 92617 0	5	Rosone rubinetto rovesciato Escutcheon simple tap Rosette Rosace en inox	ZZ 92605 0			
2	Tubetto copriasta "AR" H.15,5 Sliding cover tube "AR" H.15,5 Abdeckkappe Oberteil "AR" H.15,5 Tube couvre-tête "AR" H.15,5	ZZ 92619 0	6	Nipples 3/8" x Ø10 per sottolavabo Nipples 3/8" x Ø10 Nippel 3/8" x Ø10 Nipples 3/8" x Ø10	ZZ 92894 0			
3	Cappuccio coprivite Ø32 H.21 "AR" Escutcheon Ø32 H.21 "AR" headvalve Abdeckkappe Ø32 H.21 "AR" Rosace couvre-tête Ø32 H.21 "AR"	ZZ 92618 0						
4	Vitone 1/2" "AR" corto per motori e gruppi Headvalve 1/2" "AR" - short Oberteil 1/2" "AR" - kurz Tête 1/2" "AR" - courte	ZZ 92870 0						

AR.15

AR001460

<https://en.cisal.it/temperature-limiter-arcana-components-ar001460>

2026-04-24