

Extension +25 mm COMPONENTS_ZA008030

MODEL **ZA008030**

Extension 25 mm, for conc. single lever bath-shower mixer art.210, series LS,PU,LM,CU,CE



AVAILABLE FINISHINGS



21 21 Chrome



2A 2A Satin Brushed Nickel

CHARACTERISTICS

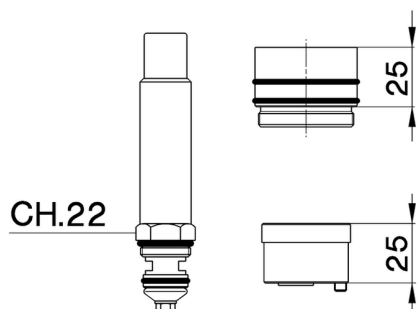

2026-06-13