









## Exposed part for single basin on the floor LESS MINIMAL\_LN014510C

MODEL **LN014510C**

Exposed part for single basin on the floor, without concealed part, for item ZA004510

### AVAILABLE FINISHINGS

-  **21** 21 Chrome
-  **2F** 2F Brushed Nickel
-  **40** 40 Matt Black
-  **4Q** 4Q Matt White
-  **2W** 2W Brushed Gold
-  **26** 26 Old Copper
-  **3W** 3W Brushed Black Titanium
-  **43** 43 Salvia
-  **44** 44 Graphite
-  **45** 45 Argilla
-  **46** 46 Metal Bronze
-  **47** 47 Cemento

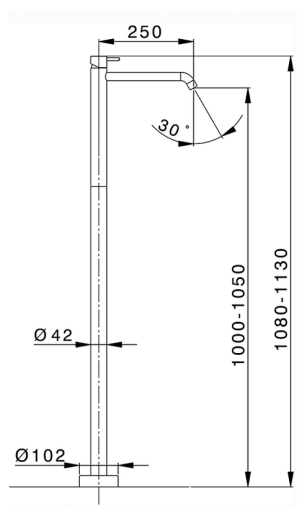

## CHARACTERISTICS

Cartridge Spare Parts **ZZ99672000**

### **35 mm Cartridge**

Installation **Concealed**

Required concealed parts **ZA004510**



### **EcoStop**

EcoStop feature limits water flow to approximately 50% of maximum output with one point of resistance on setting. Push slightly past the middle stop only when full water output is required. This will save water up to 50%.



## Concealed part single lever free-standing CONCEALED\_ZA004510

MODEL **ZA004510**

Concealed part single lever free-standing

AVAILABLE FINISHINGS

 **04** 04 Without finishing

CHARACTERISTICS

Concealed **1**

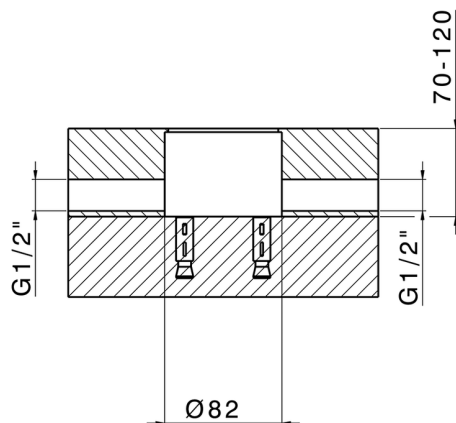

2026-06-15