

**Exposed part for single basin on the floor LESS MINIMAL\_LN014510C**

LN014510C

<https://en.cisal.it/exposed-part-for-single-basin-on-the-floor-less-minimal-ln014510c>

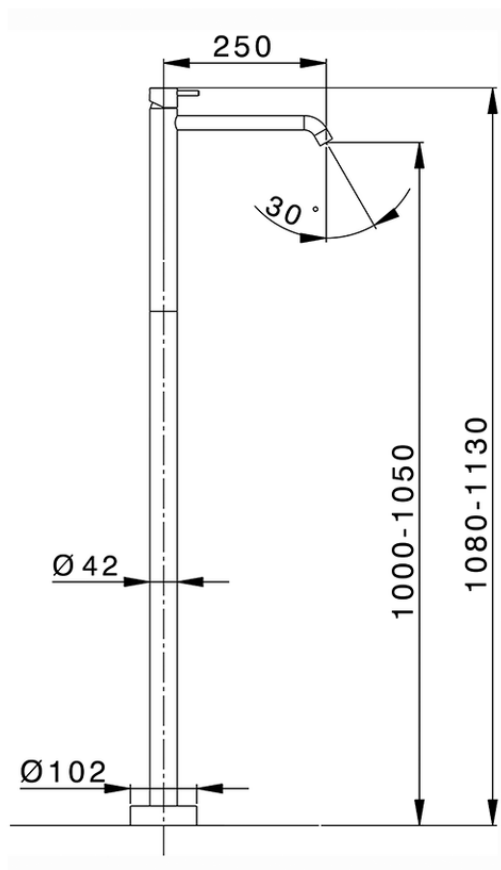

ZA004510

<https://en.cisal.it/concealed-part-single-lever-free-standing-concealed-za004510>

2026-05-19