

Cover Part for 2 Function Concealed Thermo Valve WELLNESS_CU01V200

MODEL **CU01V200**

Cover Part for 2 Function Concealed Thermo Valve, for item ZA01V200

AVAILABLE FINISHINGS

-  **21** 21 Chrome
-  **2B** 2B Polished Nickel
-  **2F** 2F Brushed Nickel
-  **40** 40 Matt Black

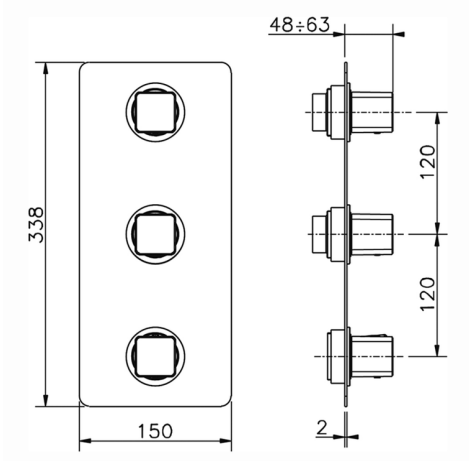

CHARACTERISTICS

Installation **Concealed**
 Required concealed parts **ZA01V200**



Thermostatic

The Cisal thermostatic is your personal water manager, helping you to handle, control and save water and energy.



2 Function Concealed Thermostatic Valve CONCEALED_ZA01V200

MODEL **ZA01V200**

2 Function Concealed Thermostatic Valve

AVAILABLE FINISHINGS



04 04 Without finishing

CHARACTERISTICS

Concealed **1**
 Cartridge Spare Parts **23.51A.HF**
HF Thermostatic Valve



Thermostatic

The Cisal thermostatic is your personal water manager, helping you to handle, control and save water and energy.



2026-04-29