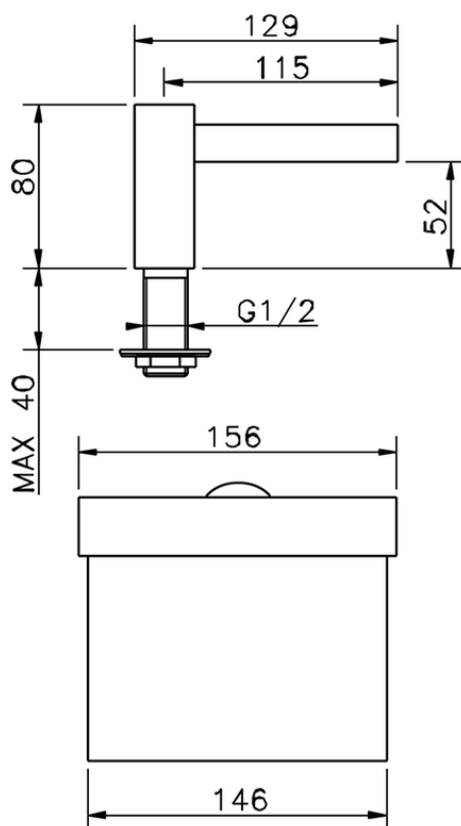

Spout COMPONENTS_ZA002620

ZA002620

<https://en.cisal.it/spout-components-za002620>

2026-04-06