

Exposed part for Single Lever One Box Valve LESS MINIMAL_LM0BM010

LM0BM010

<https://en.cisal.it/exposed-part-for-single-lever-one-box-valve-less-minimal-lm0bm010>

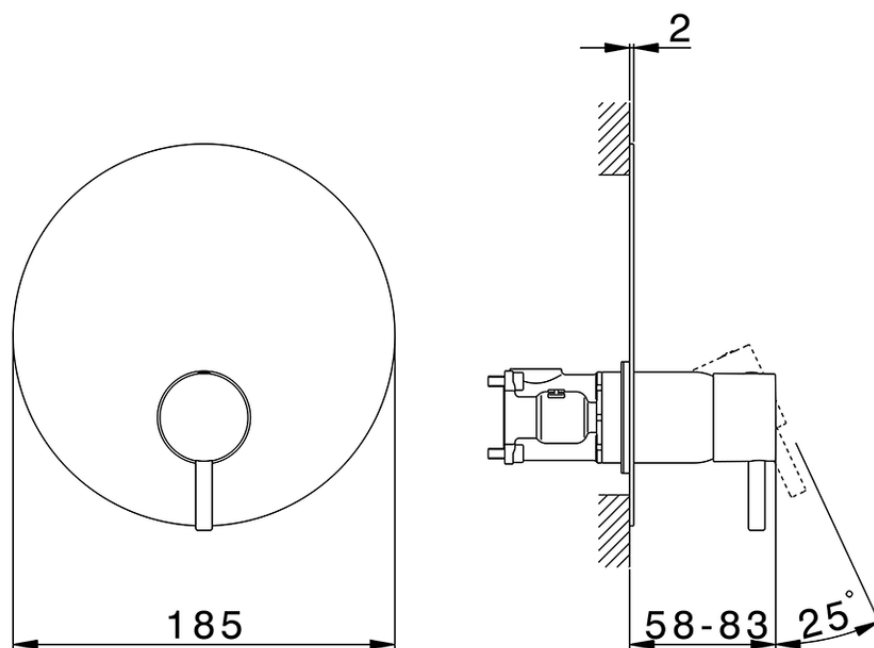

ZA00B031

<https://en.cisal.it/one-box-universal-concealed-part-one-box-za00b031>



ZA00B030

<https://en.cisal.it/one-box-universal-concealed-part-one-box-za00b030>

2026-04-05