

1 1/4 waste for basin mixer COMPONENTS_ZA001613

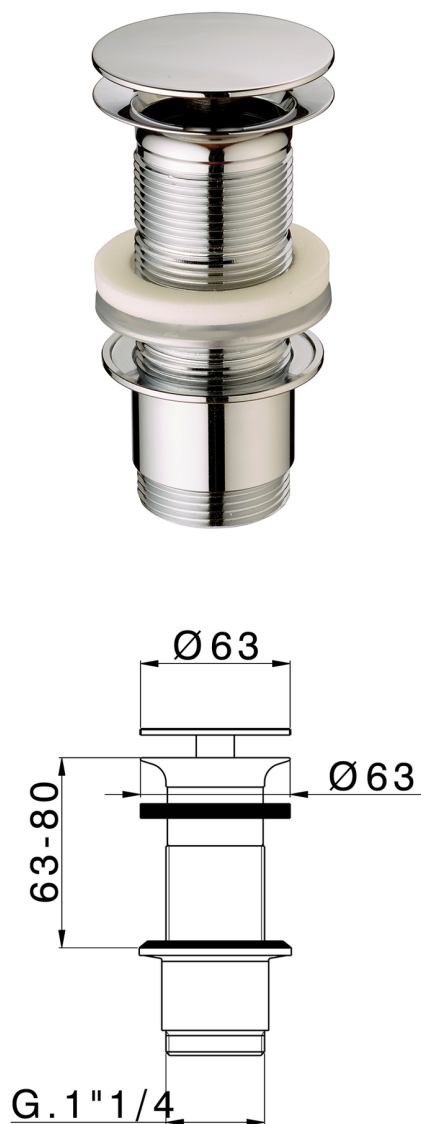

MODEL **ZA001613**

1"1/4 waste for basin mixer, always open, for bath drain system without overflow, for thickness max 80 mm

AVAILABLE FINISHINGS

-  **21** 21 Chrome
-  **24** 24 Gold
-  **27** 27 Old Bronze
-  **2B** 2B Polished Nickel
-  **2F** 2F Brushed Nickel
-  **2P** 2P Rose Gold
-  **2Q** 2Q Black Titanium
-  **40** 40 Matt Black
-  **4Q** 4Q Matt White

CHARACTERISTICS



2026-06-10