

## Cover Part for 2 Function Concealed Thermo Valve WELLNESS\_GL00R200

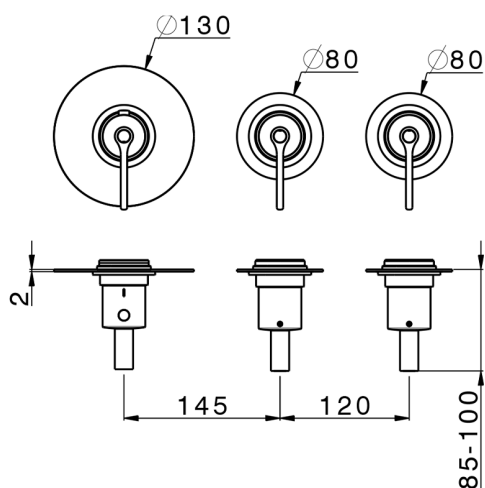

MODEL **GL00R200**

Cover Part for 2 Function Concealed Thermo Valve, for item ZA00R200 horizontal installation, for item ZA00V200 vertical installation

### AVAILABLE FINISHINGS

-  **21** 21 Chrome
-  **2F** 2F Brushed Nickel
-  **2W** 2W Brushed Gold
-  **5H** 5H Dark Brass Brushed
-  **5L** 5L Brushed Black Titanium
-  **6T** 6T Chrome/Matt Black

### CHARACTERISTICS

Installation **Concealed**  
 Required concealed parts **ZA00V200**  
**ZA00R200**



### Thermostatic

The Cisal thermostatic is your personal water manager, helping you to handle, control and save water and energy.



## 2 Function Concealed Thermostatic Valve CONCEALED\_ZA00V200

MODEL **ZA00V200**

2 Function Concealed Thermostatic Valve

AVAILABLE FINISHINGS

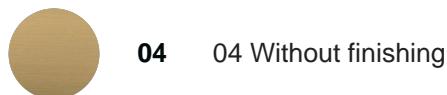

**04** 04 Without finishing

CHARACTERISTICS

Concealed **1**  
 Cartridge Spare Parts **23.51A.HF**  
**HF Thermostatic Valve**

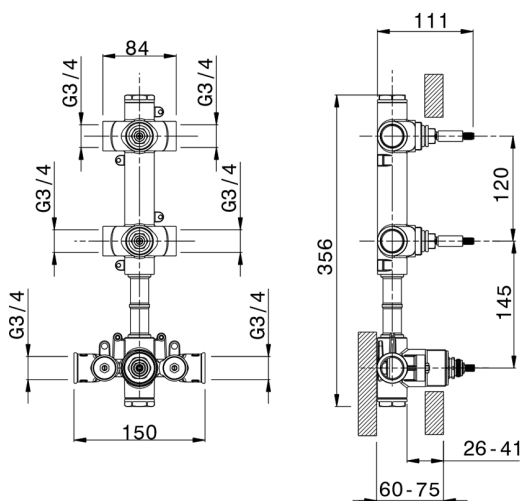

### Thermostatic

The Cisal thermostatic is your personal water manager, helping you to handle, control and save water and energy.



## 2 Function Concealed Thermostatic Valve CONCEALED\_ZA00R200

MODEL **ZA00R200**

2 Function Concealed Thermostatic Valve

AVAILABLE FINISHINGS

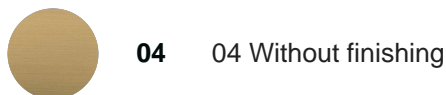

CHARACTERISTICS

Concealed **1**  
 Cartridge Spare Parts **23.51A.HF**  
**HF Thermostatic Valve**

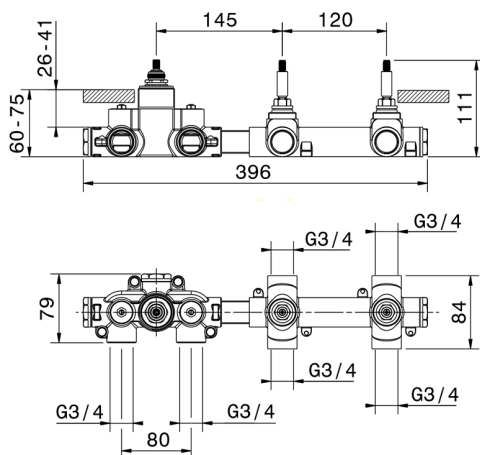

### Thermostatic

The Cisal thermostatic is your personal water manager, helping you to handle, control and save water and energy.



2025-01-05