

## Extension +25 mm COMPONENTS\_ZA008300

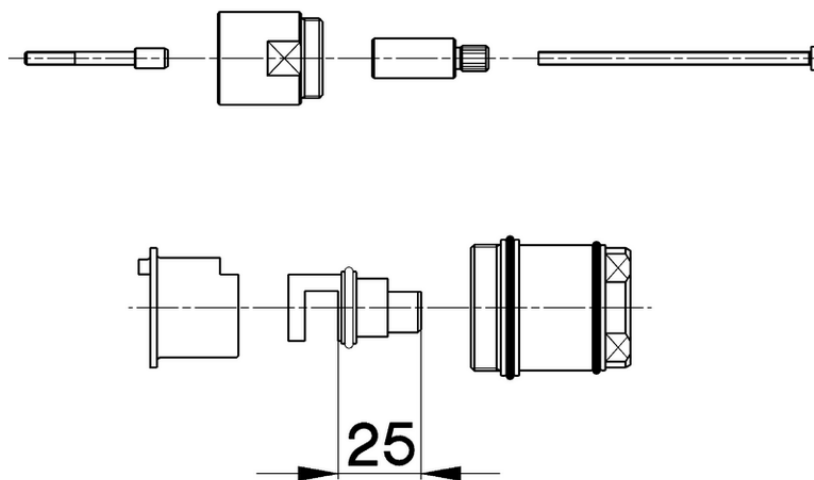

ZA008300

<https://en.cisal.it/extension-25-mm-components-za008300>

2026-04-29