

## Exposed part for con.thermo.shower valve, 3-outlet SMOOTH X32\_X3018200

MODEL **X3018200**

Exposed part for con.thermo.shower valve, 3-outlet,with 3 outlet deviasstop,without concealed part,for item ZA018201,with smooth handles - Inox AISI 316L

### AVAILABLE FINISHINGS

-  **D1** D1 Brushed Inox
-  **5H** 5H Dark Brass Brushed
-  **5L** 5L Brushed Black Titanium
-  **5N** 5N Brushed Rose Gold

### CHARACTERISTICS

Installation **Concealed**  
 Required concealed parts **ZA018201**

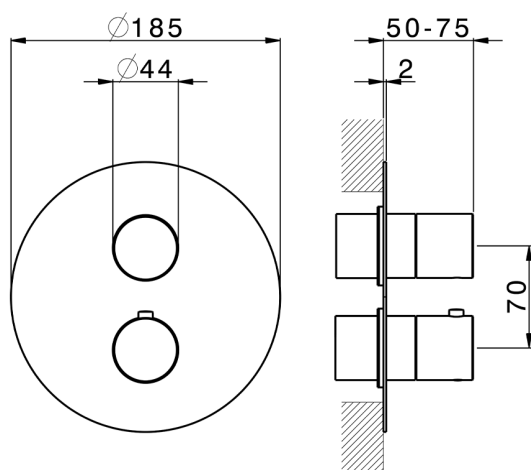
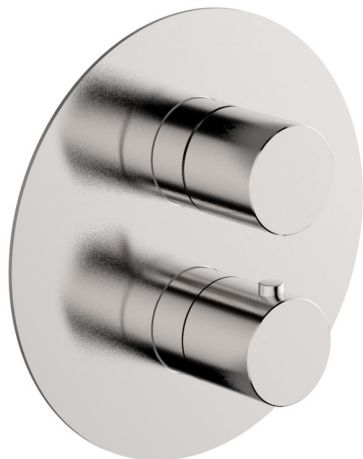

### Thermostatic

The Cisal thermostatic is your personal water manager, helping you to handle, control and save water and energy.



## Exposed part for con.thermo.shower valve, 3-outlet SMOOTH X32\_X3018200

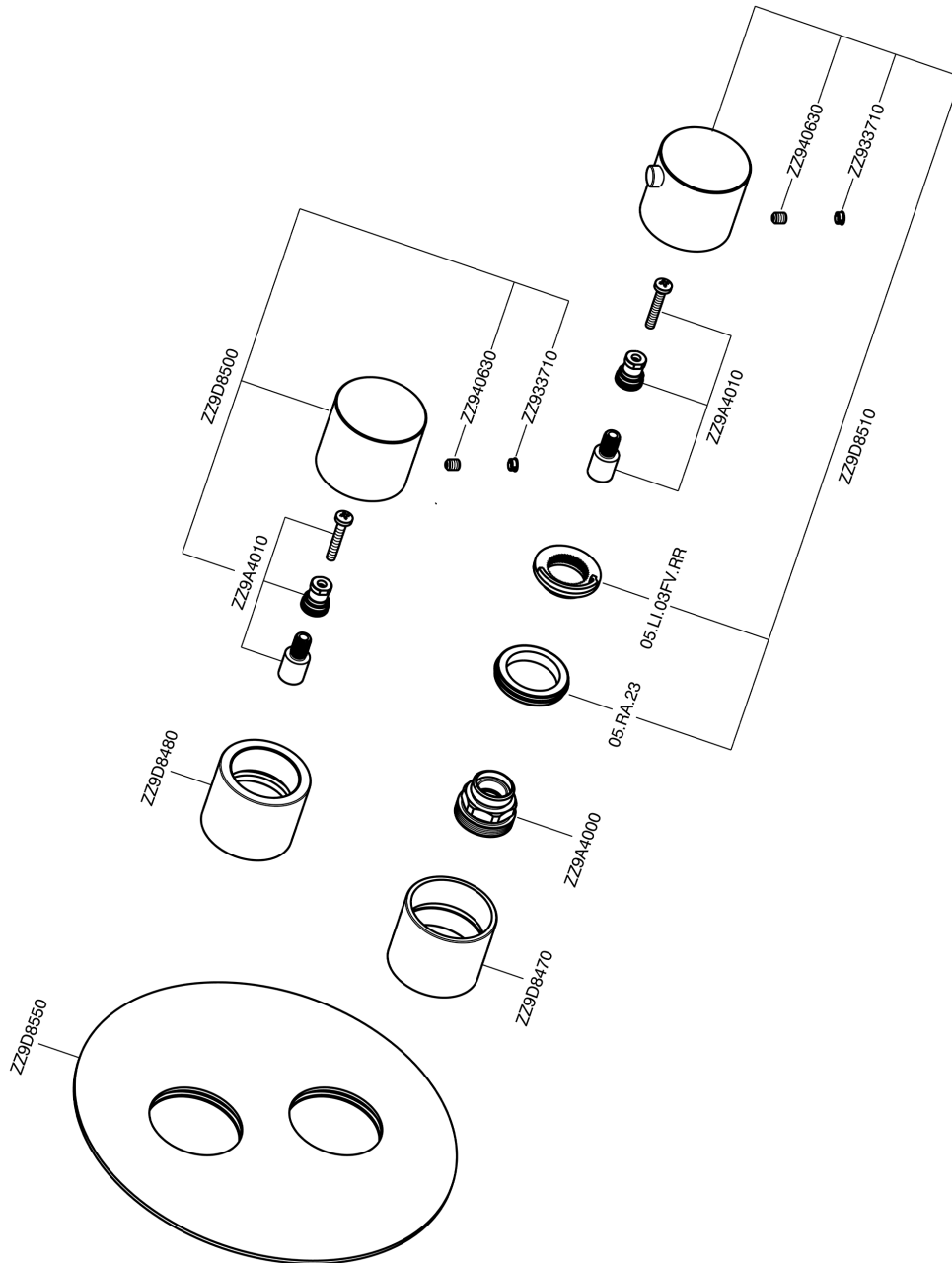

X3018200

<https://en.cisal.it/exposed-part-for-con-thermo-shower-valve-3-outlet-smooth-x32-x3018200>

## Concealed thermostatic shower valve, 3-outlets CONCEALED\_ZA018201

MODEL **ZA018201**

Concealed thermostatic shower valve, 3-outlets, with 1/2" 3 outlet deviastop cartridge, without trim kit



AVAILABLE FINISHINGS



**04** 04 Without finishing

CHARACTERISTICS

Concealed **1**  
Cartridge Spare Parts **24.04A.PP**

**8x20 Plus P Thermostatic Valve**

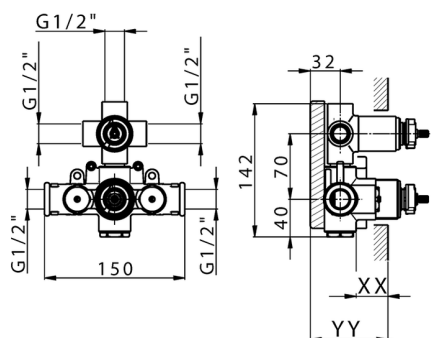

Piastra/Plate/Plaque/Platte/Placa

2-3mm: XX 25-40 YY 76-91

10 mm: XX 16-31 YY 65-80



### DeviaStop

The Cisal Devia Stop technology allows to adjust the water flow and to direct it to the selected output point (overhead soaker, hand shower, etc).



### Thermostatic

The Cisal thermostatic is your personal water manager, helping you to handle, control and save water and energy.



2026-06-10