





## Cover Part for 2 Function Concealed Thermo. Valve WELLNESS\_SM01R200

MODEL **SM01R200**

Cover Part for 2 Function Concealed Thermo.Valve,for item ZA01R200

### AVAILABLE FINISHINGS

-  **21** 21 Chrome
-  **2B** 2B Polished Nickel
-  **40** 40 Matt Black
-  **4Q** 4Q Matt White

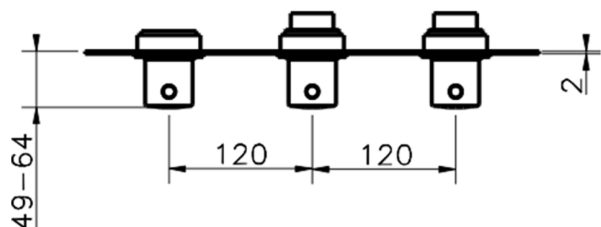
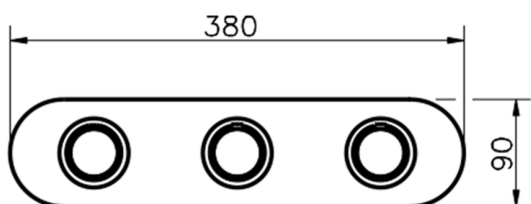
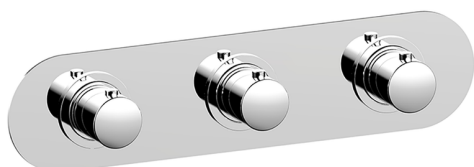

### CHARACTERISTICS

Installation **Concealed**  
 Required concealed parts **ZA01R200**



### Thermostatic

The Cisal thermostatic is your personal water manager, helping you to handle, control and save water and energy.



## 2 Function Concealed Thermostatic Valve CONCEALED\_ZA01R200

MODEL **ZA01R200**

2 Function Concealed Thermostatic Valve

AVAILABLE FINISHINGS



**04** 04 Without finishing



CHARACTERISTICS

Concealed **1**  
 Cartridge Spare Parts **23.51A.HF**  
**HF Thermostatic Valve**

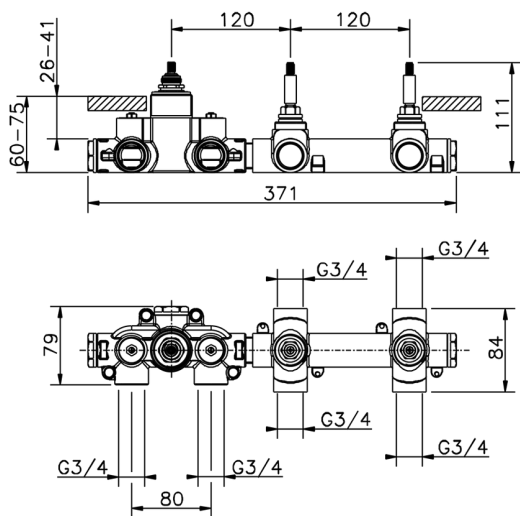

### Thermostatic

The Cisal thermostatic is your personal water manager, helping you to handle, control and save water and energy.



2024-12-29