

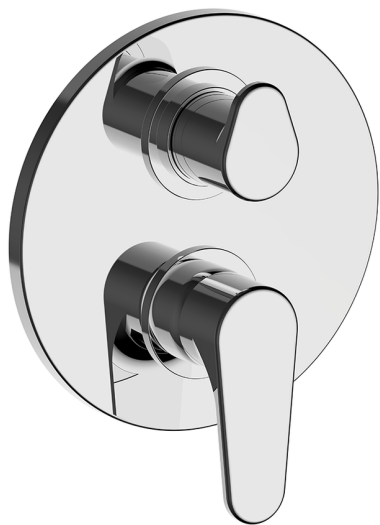



## Exposed part for Single Lever One Box Valve ALMA\_A30BM030



MODEL **A30BM030**

Exposed part for Single Lever One Box Valve, with 2-3 outlet diverter, Minimum depth of installation: 67 mm, without concealed part, for items ZA00B030-ZA00B031

### AVAILABLE FINISHINGS

-  **21** 21 Chrome
-  **2F** 2F Brushed Nickel
-  **40** 40 Matt Black

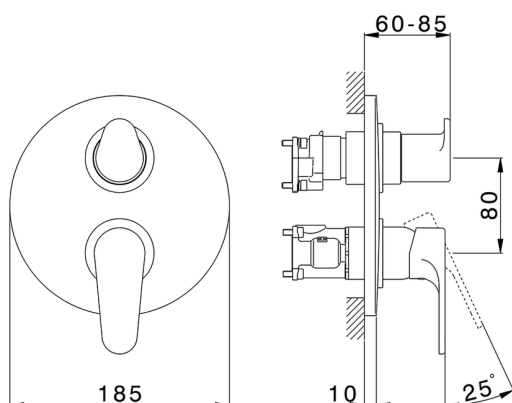

### CHARACTERISTICS

Cartridge Spare Parts **ZZ97179000**

**35 mm Cartridge**

Installation **Concealed**

Required concealed parts **ZA00B031**

**ZA00B030**



## Exposed part for Single Lever One Box Valve ALMA\_A30BM030

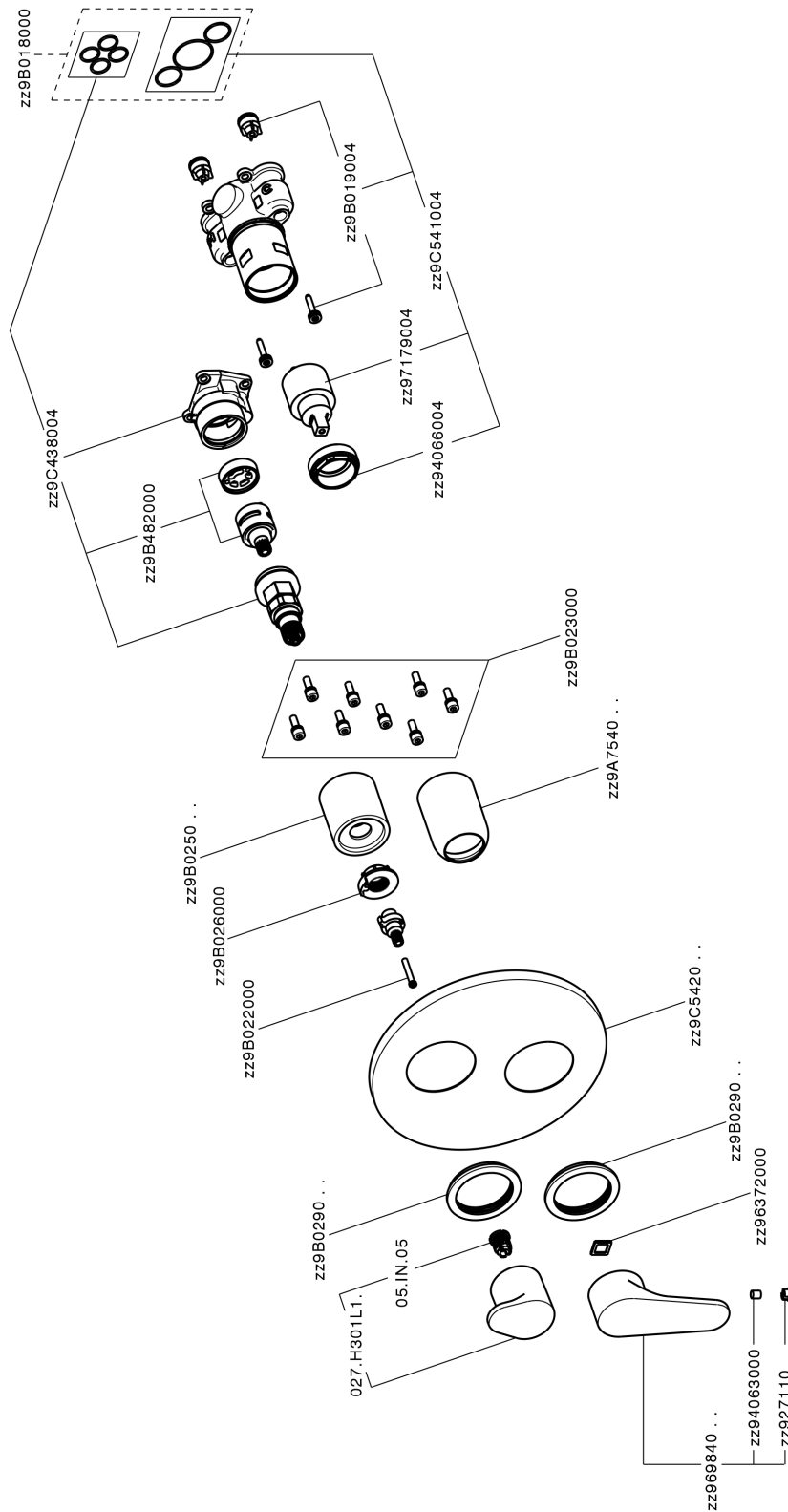

A30BM030

<https://en.cisal.it/exposed-part-for-single-lever-one-box-valve-agma-a30bm030>

## One Box Universal Concealed Part ONE BOX\_ZA00B031

MODEL **ZA00B031**

One Box Universal Concealed Part, for 1, 2 or 3 outlet thermostatic or single lever, without trim kit, with noise reducers, with sealing gasket

AVAILABLE FINISHINGS

 **04** 04 Without finishing

CHARACTERISTICS

Concealed **1**



### Thermostatic

The Cisal thermostatic is your personal water manager, helping you to handle, control and save water and energy.



## One Box Universal Concealed Part ONE BOX\_ZA00B030

MODEL **ZA00B030**

One Box Universal Concealed Part, for 1, 2 or 3 outlet thermostatic or single lever, without trim kit, without noise reducers, with sealing gasket

AVAILABLE FINISHINGS

 **04** 04 Without finishing

CHARACTERISTICS

Concealed **1**



### Thermostatic

The Cisal thermostatic is your personal water manager, helping you to handle, control and save water and energy.



2026-04-30