

Exposed part for con.thermo. bath mixer, 2-outlet GRACE_GS019441

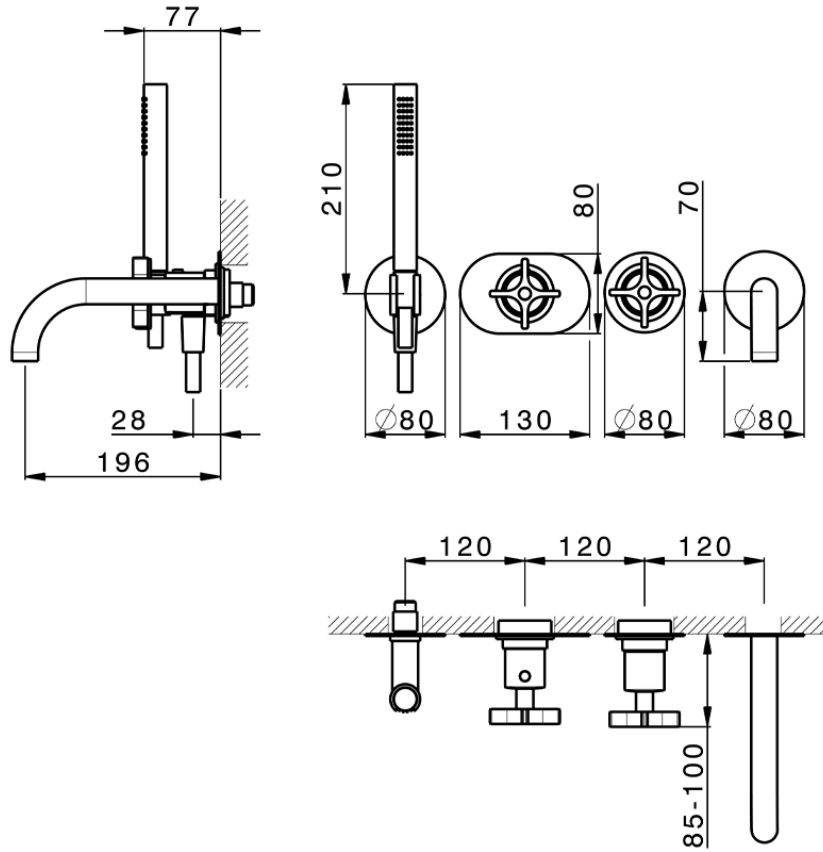

GS019441

<https://en.cisal.it/exposed-part-for-con-thermo-bath-mixer-2-outlet-grace-gs019441>

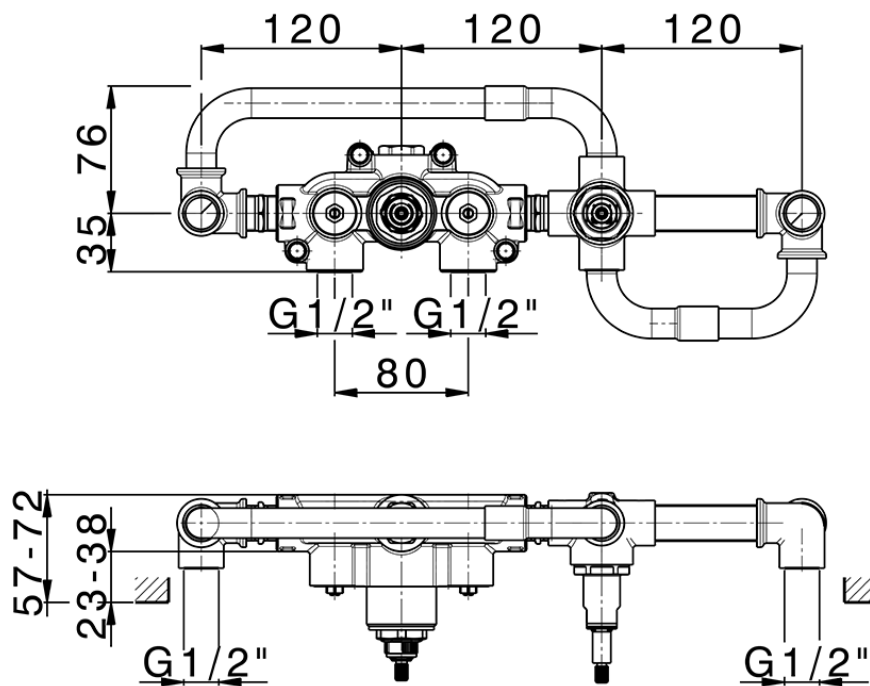

ZA019440

<https://en.cisal.it/concealed-thermostatic-bath-mixer-2-outlets-concealed-za019440>

2026-06-14