

## Exposed part for con.thermo.shower valve, 2-outlet ARCANA CERAMIC\_AC018100

MODEL **AC018100**

Exposed part for con.thermo.shower valve, 2-outlet, with 2 outlet deviator, without concealed part, for item ZA018101

### AVAILABLE FINISHINGS

-  **21** 21 Chrome
-  **24** 24 Gold
-  **26** 26 Old Copper
-  **27** 27 Old Bronze
-  **2A** 2A Satin Brushed Nickel

### CHARACTERISTICS

Installation **Concealed**  
 Required concealed parts **ZA018101**

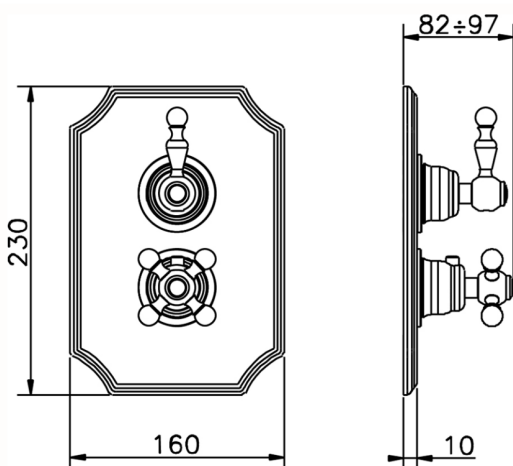
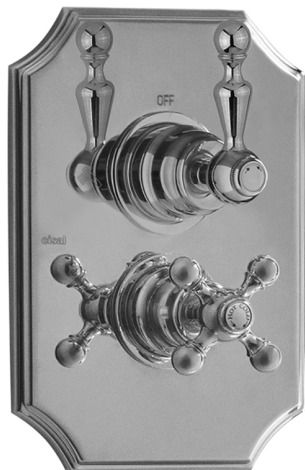

### Thermostatic

The Cisal thermostatic is your personal water manager, helping you to handle, control and save water and energy.



## Exposed part for con.thermo.shower valve, 2-outlet ARCANA CERAMIC\_AC018100

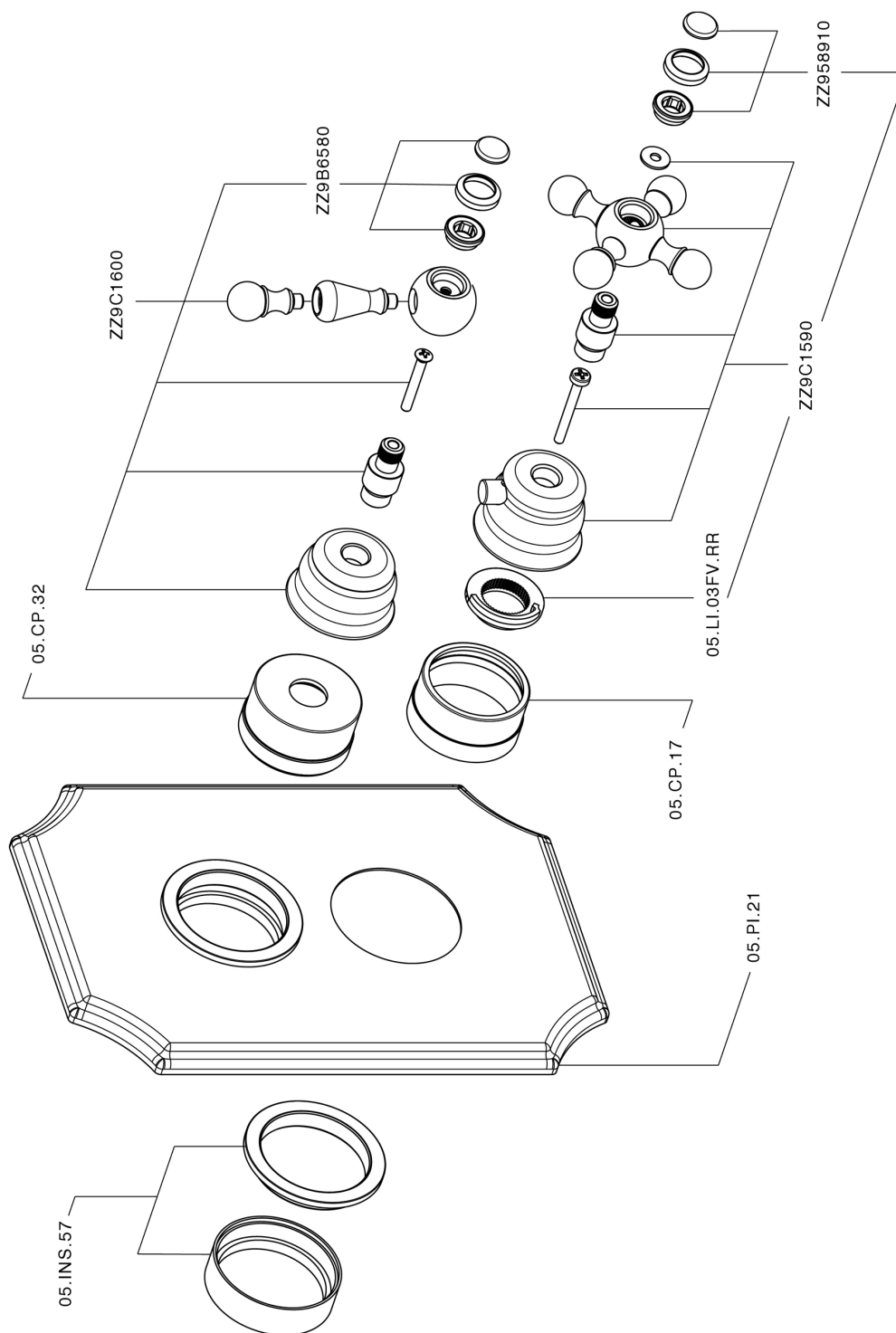

AC018100

<https://en.cisal.it/exposed-part-for-con-thermo-shower-valve-2-outlet-arcana-ceramic-ac018100>

## Concealed thermostatic shower valve, 2-outlets CONCEALED\_ZA018101

MODEL **ZA018101**

Concealed thermostatic shower valve, 2-outlets, with 1/2" 2 outlet devia stop cartridge, without trim kit

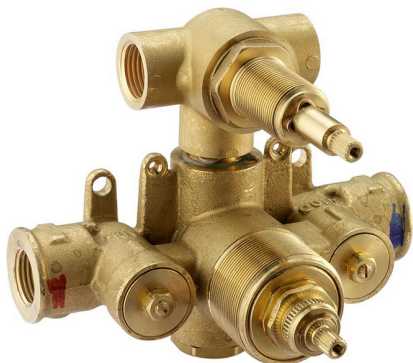

AVAILABLE FINISHINGS

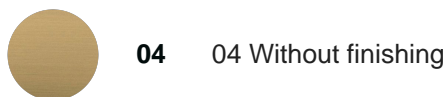

CHARACTERISTICS

Concealed **1**  
 Cartridge Spare Parts **24.04A.PP**  
**8x20 Plus P Thermostatic Valve**

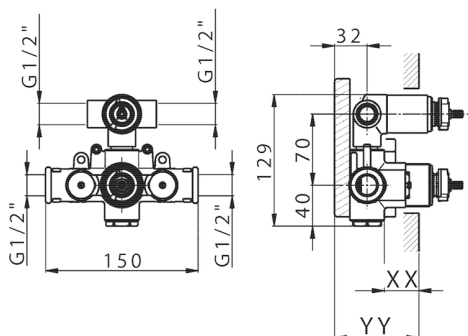

Piastra/Plate/Plaque/Platte/Placa

2-3mm: XX 25-40 YY 76-91

10 mm: XX 16-31 YY 65-80



### DeviaStop

The Cisal Devia Stop technology allows to adjust the water flow and to direct it to the selected output point (overhead soaker, hand shower, etc).



### Thermostatic

The Cisal thermostatic is your personal water manager, helping you to handle, control and save water and energy.



2026-05-20