

Exposed part for con.thermo.shower valve, 3-outlet NUANCE X32_X1018200

MODEL **X1018200**

Exposed part for con.thermo.shower valve, 3-outlet, with 3 outlet deviasstop, without concealed part, for item ZA018201, Inox AISI 316L

AVAILABLE FINISHINGS

-  **D1** D1 Brushed Inox
-  **5H** 5H Dark Brass Brushed
-  **5L** 5L Brushed Black Titanium
-  **5N** 5N Brushed Rose Gold

CHARACTERISTICS

Installation **Concealed**
 Required concealed parts **ZA018201**

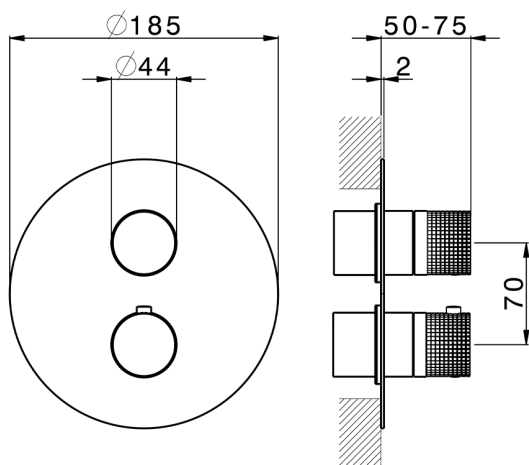
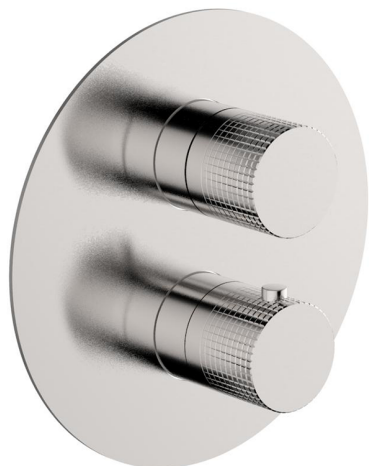

Thermostatic

The Cisal thermostatic is your personal water manager, helping you to handle, control and save water and energy.



Exposed part for con.thermo.shower valve, 3-outlet NUANCE X32_X1018200

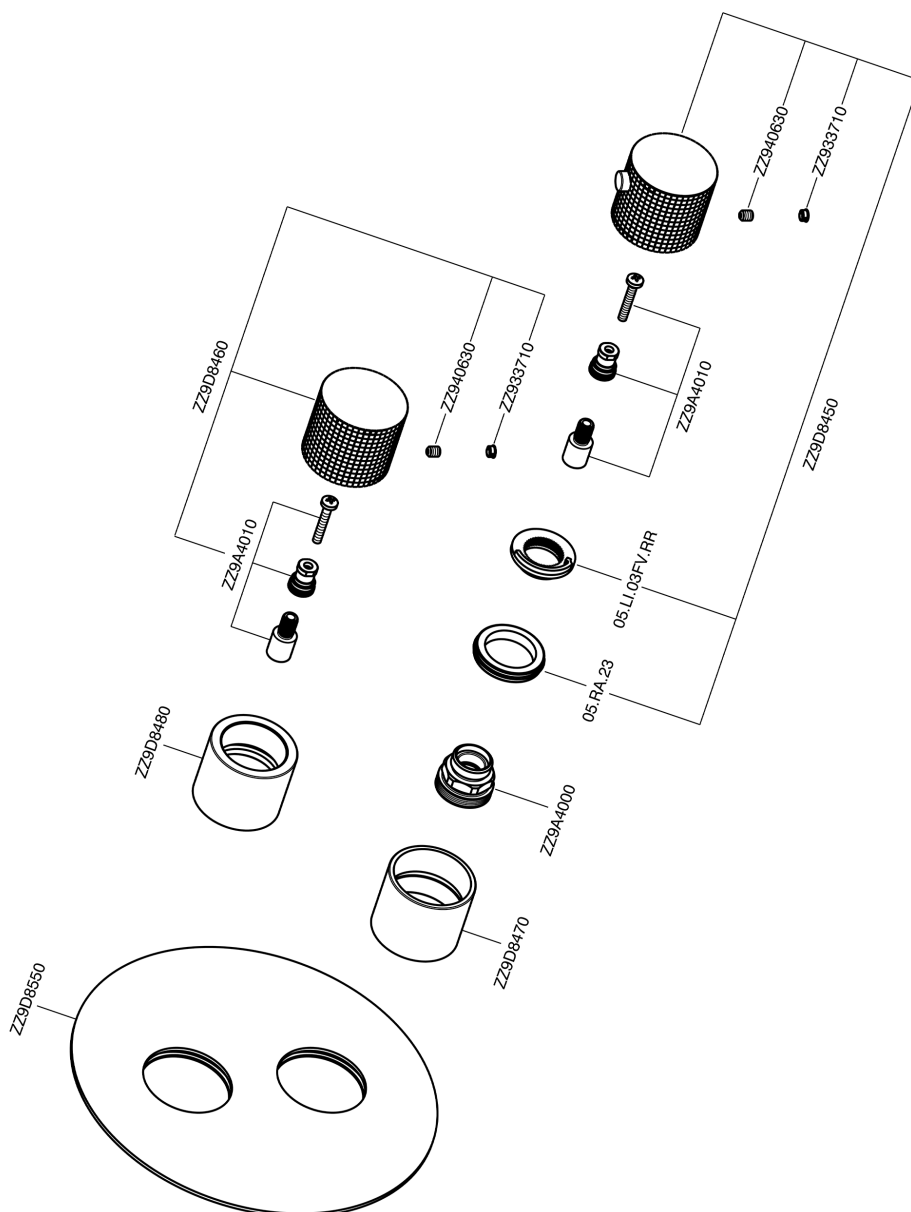

X1018200

<https://en.cisal.it/exposed-part-for-con-thermo-shower-valve-3-outlet-nuance-x32-x1018200>

Concealed thermostatic shower valve, 3-outlets CONCEALED_ZA018201

MODEL **ZA018201**

Concealed thermostatic shower valve, 3-outlets, with 1/2" 3 outlet deviastop cartridge, without trim kit



AVAILABLE FINISHINGS



CHARACTERISTICS

Concealed **1**
 Cartridge Spare Parts **24.04A.PP**
8x20 Plus P Thermostatic Valve

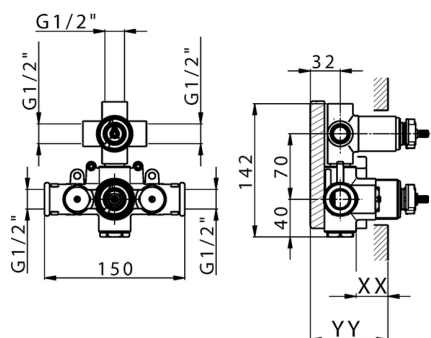

Piastra/Plate/Plaque/Platte/Placa
 2-3mm: XX 25-40 YY 76-91
 10 mm: XX 16-31 YY 65-80



DeviaStop

The Cisal Devia Stop technology allows to adjust the water flow and to direct it to the selected output point (overhead soaker, hand shower, etc).



Thermostatic

The Cisal thermostatic is your personal water manager, helping you to handle, control and save water and energy.



2026-05-17