

## Exposed simple tap TR\_TR001430

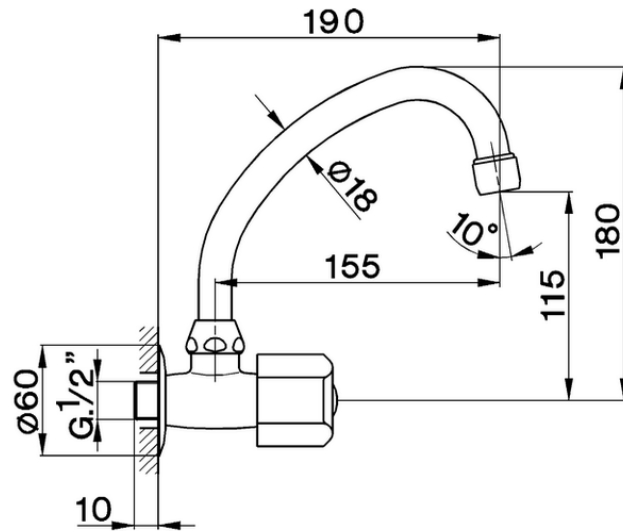

TR001430

<https://en.cisal.it/exposed-simple-tap-tr-tr001430>

2026-06-14