

Single lever washbasin mixer large EnergySave TENDER_C2000505



MODEL **C2000505**

Single lever washbasin mixer " large " EnergySave,without automatic pop-up waste,G.3/8" stainless steel flexible hoses

AVAILABLE FINISHINGS



CHARACTERISTICS

Cartridge Spare Parts **ZZ96800000**

35 mm Cartridge

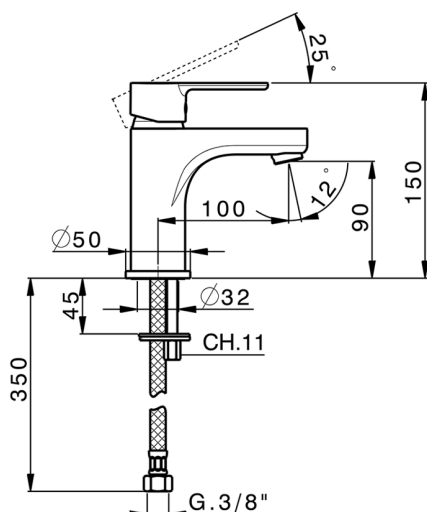

EcoStop

EcoStop feature limits water flow to approximately 50% of maximum output with one point of resistance on setting. Push slightly past the middle stop only when full water output is required. This will save water up to 50%.



EnergySave

Thanks to the EnergySave device, only cold water will be drawn if the lever is operated in the central position, so that the water heater will not be engaged and no hot water wasted, leading to considerable savings in energy and costs. The temperature can be adjusted by rotating the lever to the left, until the desired temperature is reached.



Single lever washbasin mixer large EnergySave TENDER_C2000505

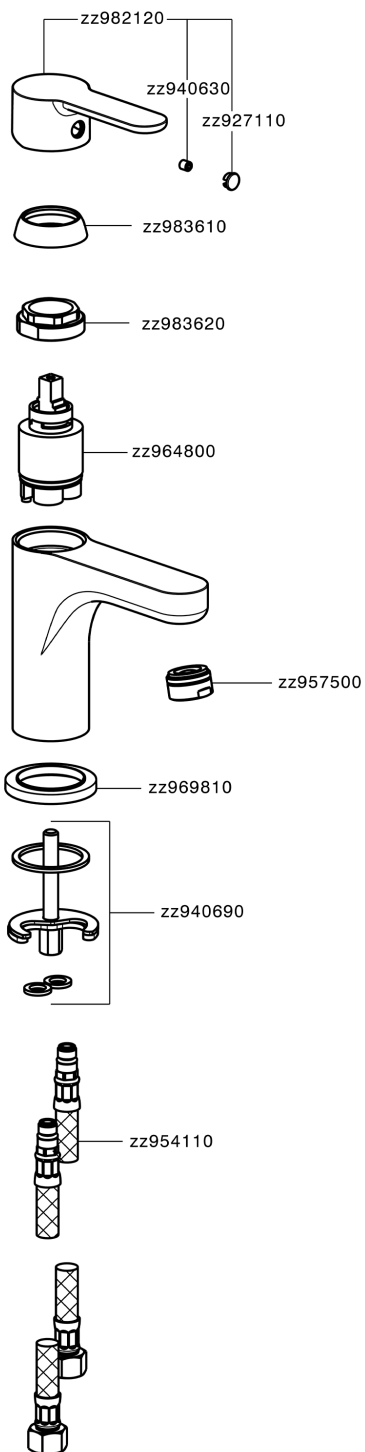

C2000505

<https://en.cisal.it/single-lever-washbasin-mixer-large-energysave-tender-c2000505>

2024-12-22