

## 1 1/4 S-shaped siphon COMPONENTS\_ZA004060

MODEL **ZA004060**

1"1/4 S-shaped siphon

AVAILABLE FINISHINGS



CHARACTERISTICS

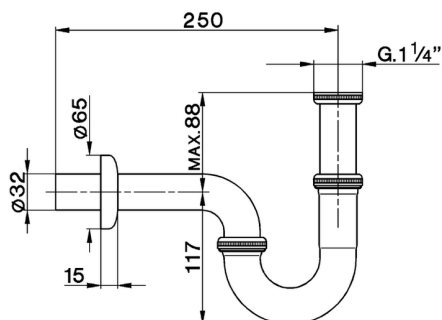

2026-04-08