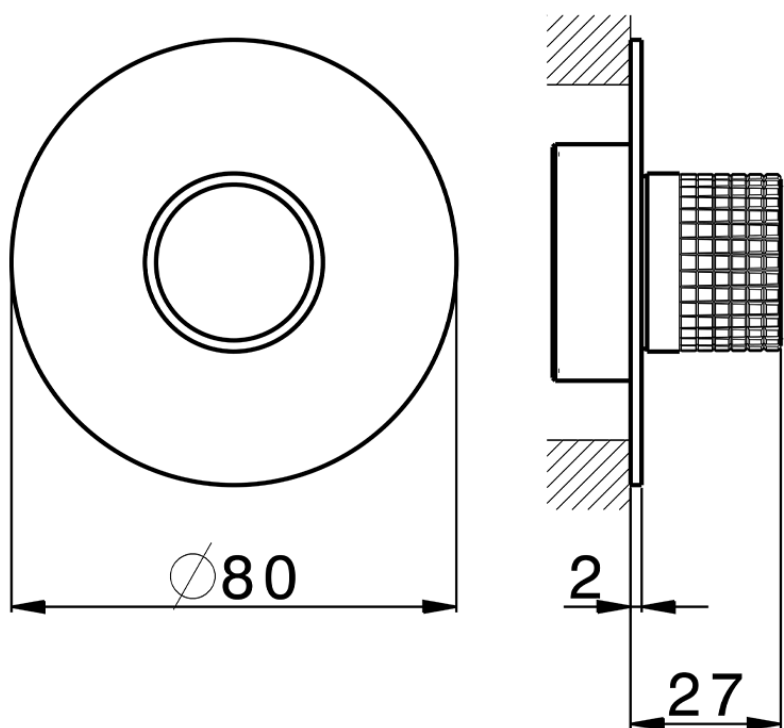

**Exposed part for individual Push&Shower PUSH&SHOWER\_PS1G6120**

PS1G6120

<https://en.cisal.it/exposed-part-for-individual-pushshower-pushshower-ps1g6120>

2026-04-28