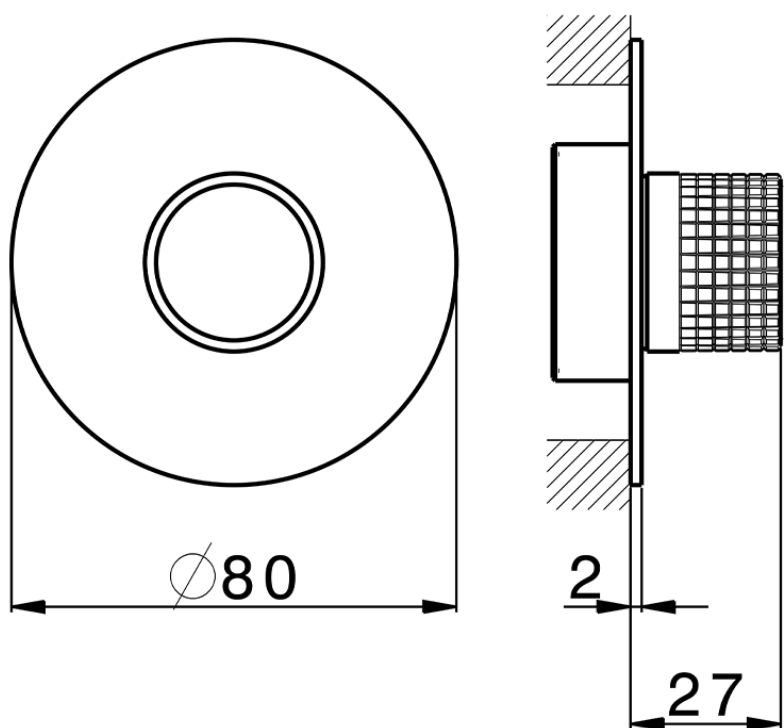

Exposed part for individual Push&Shower PUSH&SHOWER_PS1G6120

PS1G6120

<https://en.cisal.it/exposed-part-for-individual-pushshower-pushshower-ps1g6120>

2026-04-08