

Washbasin mixer BARCELONA_BA000510

cisal

BA 00051

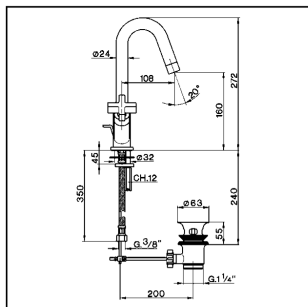

- Monoforo lavabo
- Single hole basin mixer
- Einloch Waschtischbatterie
- Mélangeur monotrou lavabo

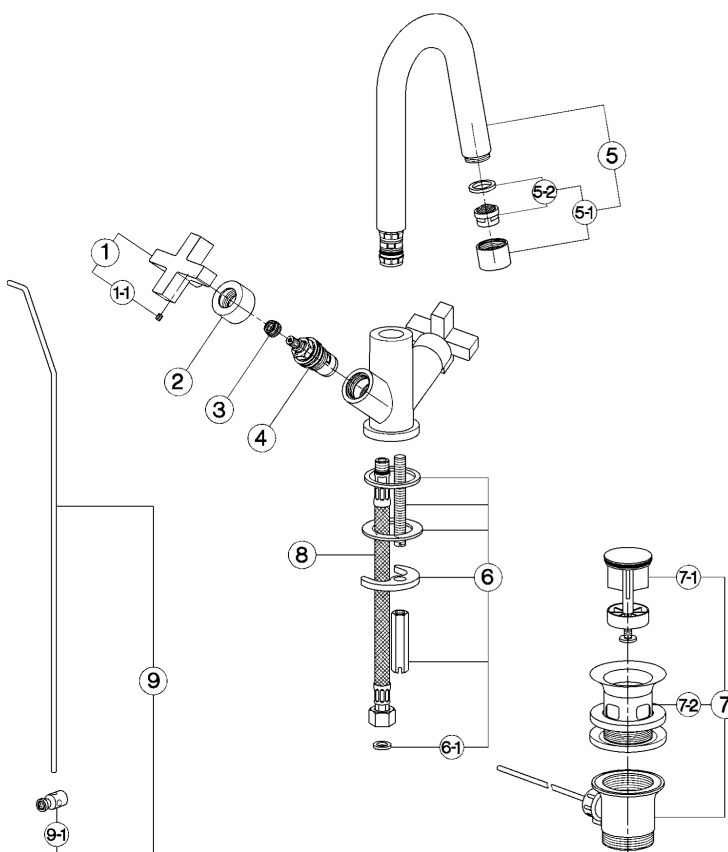

bar	PORTATA BOCCA DI EROGAZIONE * SPOUT FLOW RATE DURCHFLOSS WANNENEINLAUF DEBIT BEC DEVERSEUR l/min.
0,5	6
1	8
2	11,5
3	14
4	16
5	18

* con resistenza silenziosa della classe di portata A (15 l/min. a 3 bar)
with hydraulic resistance of flow rate class A (15 l/min. at 3 bar)
mit geräuscharmen Widerstand der Durchflussklasse A (15 l/min. bei 3 bar)
avec aérateur classe A (15 l/min. à 3 bar)

NR.	DESCRIZIONE DESCRIPTION BESCHREIBUNG DESCRIPTION	N. CODICE CODE NO. WERKSNR. NR. CODE	NR.	DESCRIZIONE DESCRIPTION BESCHREIBUNG DESCRIPTION	N. CODICE CODE NO. WERKSNR. NR. CODE	NR.	DESCRIZIONE DESCRIPTION BESCHREIBUNG DESCRIPTION	N. CODICE CODE NO. WERKSNR. NR. CODE
1	Maniglia "BA" per monofori Handle "BA" for single hole mixer Griff "BA" f/Einloch-Batterien Croisillon "BA" pour mélangeur monotrou	ZZ 93289 0	5-1	Aeratore M.22x1 IA Cascade Mousseur M.22x1 IA Cascade Perlator M.22x1 IA Cascade Mousseur M.22x1 IA Cascade	ZZ 93283 0	7-2	Piletta per scarico automatico 1" 1/4 Waste for bath drain 1" 1/4 Ablauf f/Ablaufgarnitur 1" 1/4 Crépine pour vidage 1" 1/4	ZZ 92924 0
1-1	Grano punta plana inox M.4x4 Screw-stainless steel M.4x4 Mädenschraube M.4x4 Vis speciale inox M.4x4	ZZ 93328 0	5-2	Cartuccia per aeratore M. 22x1 Cascade Mousseur cartridge M.22x1 Cascade Kart. f/Perlator M.22x1 Cascade Cartouche x mousseur M.22x1 Cascade	ZZ 93339 0	8	Flessibile M.11x1 3/8" L.365 Flex M.11x1 3/8" L.365 Anschlusschlauch M.11x1 3/8" L.365 Flex M.11x1 3/8" L.365	ZZ 92842 0
2	Cappuccio coprivite "BA" Escutcheon "BA" Abdeckkappe "BA" Rosace couvre-tête "BA"	ZZ 93327 0	6	Set installazione monocomando monoforo Installation set single hole Befestigungsset Set installation	ZZ 92899 0	9	Astina scarico completa Ø4 Rod Ø4 Zugstange Ø4 Tige Ø4	ZZ 93340 0
3	Riduzione brocciata completa Complete broached reduction piece Verkürzung Raumwerkzeug komplett Réduction avec brochage complète	ZZ 93330 0	6-1	Guarnizione fibre 3/8" Gasket rubber 3/8" Fiberrichtung 3/8" Joint en fibre 3/8"	ZZ 92696 0	9-1	Morsetto astina scarico automatico Connection for pop-up rod Gelenkstück f/Zugstange Jonction x tige vidage	ZZ 93343 0
4	Vitone ceramico 1/2" DX 90° Ceramic headvalve 1/2" right 90° Keramikoberteil 1/2" - rechts - 90° Tête céram. 1/2" droite 90°	ZZ 92907 0	7	Scarico automatico 1" 1/4 sabbiato Pop-up waste 1" 1/4 Ablaufgarnitur 1" 1/4 Vidage automat. 1" 1/4	ZZ 92754 0			
5	Canna sagonata Ø24 int.rose 108 Swinging spout 108 Ø24 Auslauf-Rohr-U-108 Ø24 Bec orientable 108 Ø24	ZZ 93286 0	7-1	Tappo completo scarico automatico 1" 1/4 Plug for pop-up waste 1" 1/4 Stopfen f/Ablaufg. kpl 1" 1/4 Bonde - vidage 1" 1/4	ZZ 92925 0			

BA.10

BA000510

<https://en.cisal.it/washbasin-mixer-barcelona-ba000510>

2026-06-05