

2 Function Concealed Thermostatic Valve CONCEALED_ZA01R200

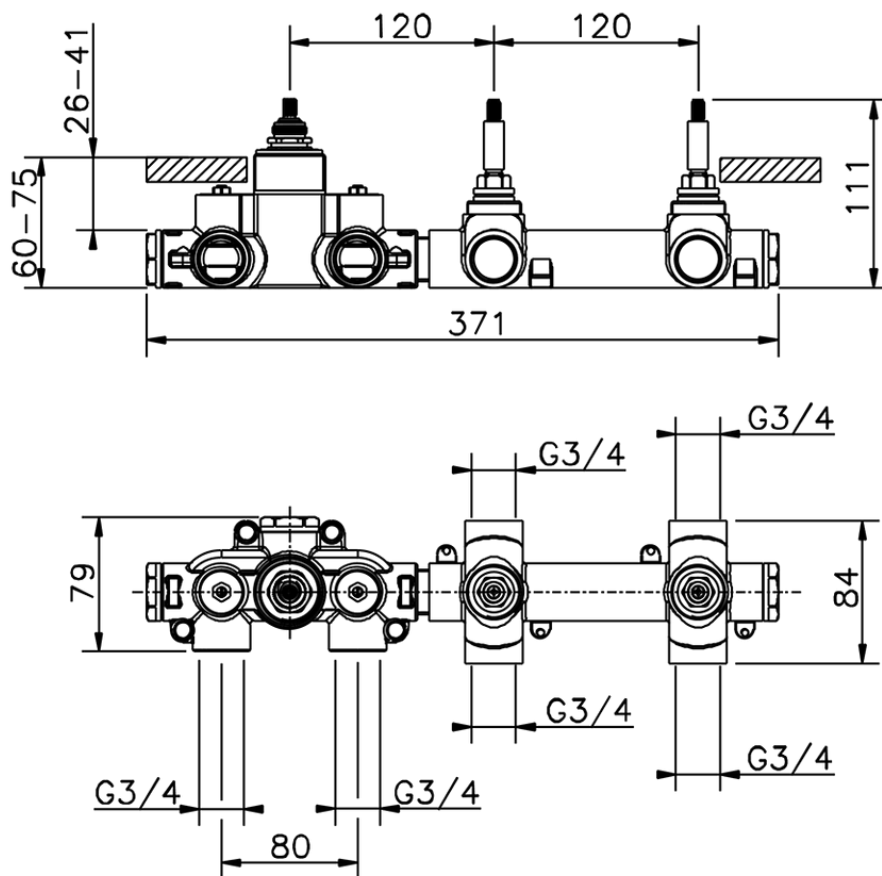

ZA01R200

<https://en.cisal.it/2-function-concealed-thermostatic-valve-concealed-za01r200>

2026-06-14