

## Exposed simple tap TR\_TR001440

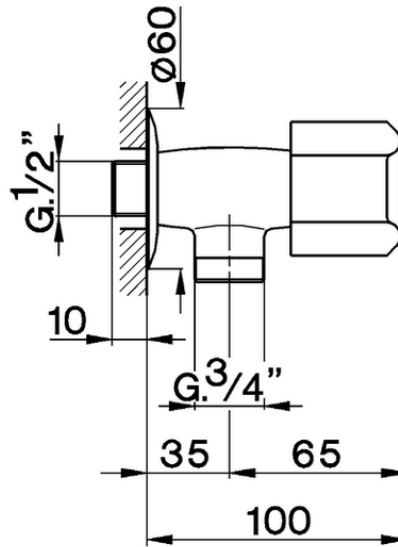

TR001440

<https://en.cisal.it/exposed-simple-tap-tr-tr001440>

2026-04-08