

Thermostatic bath mixer VITA_VIT21010

MODEL **VIT21010**

Thermostatic bath mixer, without shower set, 1/2" M flexible connection

AVAILABLE FINISHINGS

-  **21** 21 Chrome
-  **2Q** 2Q Black Titanium
-  **40** 40 Matt Black
-  **4Q** 4Q Matt White

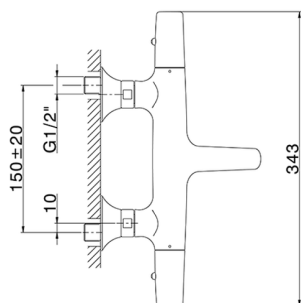
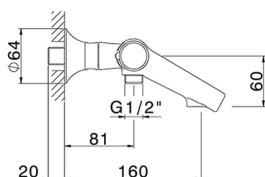

CHARACTERISTICS

Cartridge Spare Parts **ZZ96551000**

TMX 25 Thermostatic Valve



DeviaStop

The Cisal Devia Stop technology allows to adjust the water flow and to direct it to the selected output point (overhead soaker, hand shower, etc).



SafeTouch

The Cisal SafeTouch system maintains the mixer body cool to the touch during operation.



Thermostatic

The Cisal thermostatic is your personal water manager, helping you to handle, control and save water and energy.



Thermostatic bath mixer VITA_VIT21010

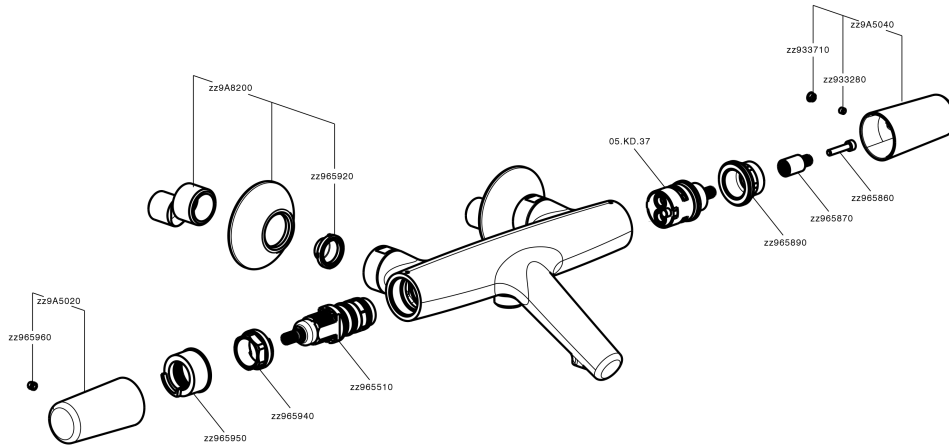

VIT21010

<https://en.cisal.it/thermostatic-bath-mixer-vita-vit21010>

2026-05-17