

Exposed part for thermostatic concealed valve PUSH&SHOWER_PS1G1030



MODEL **PS1G1030**

Exposed part for thermostatic concealed valve, without concealed valve, 80x80mm square plate, for Th. concealed valve with protection guard box

AVAILABLE FINISHINGS

-  **21** 21 Chrome
-  **24** 24 Gold
-  **26** 26 Old Copper
-  **2B** 2B Polished Nickel
-  **2F** 2F Brushed Nickel
-  **2W** 2W Brushed Gold
-  **3W** 3W Brushed Black Titanium
-  **5G** 5G Rose Gold
-  **40** 40 Matt Black

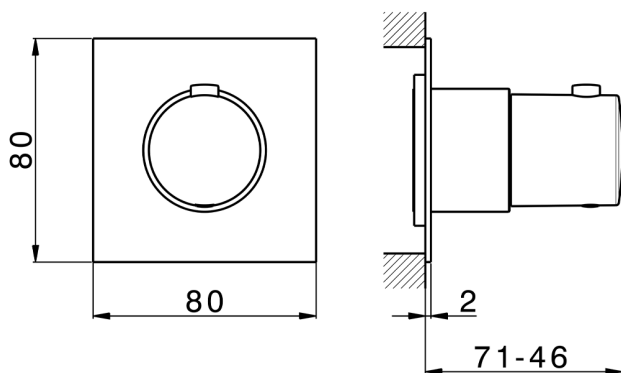

Thermostatic

The Cisal thermostatic is your personal water manager, helping you to handle, control and save water and energy.

CHARACTERISTICS

Installation **Concealed**
 Required concealed parts **ZA0G1000**



2026-06-16