

Exposed part for thermostatic concealed valve PUSH&SHOWER_PS1G1030

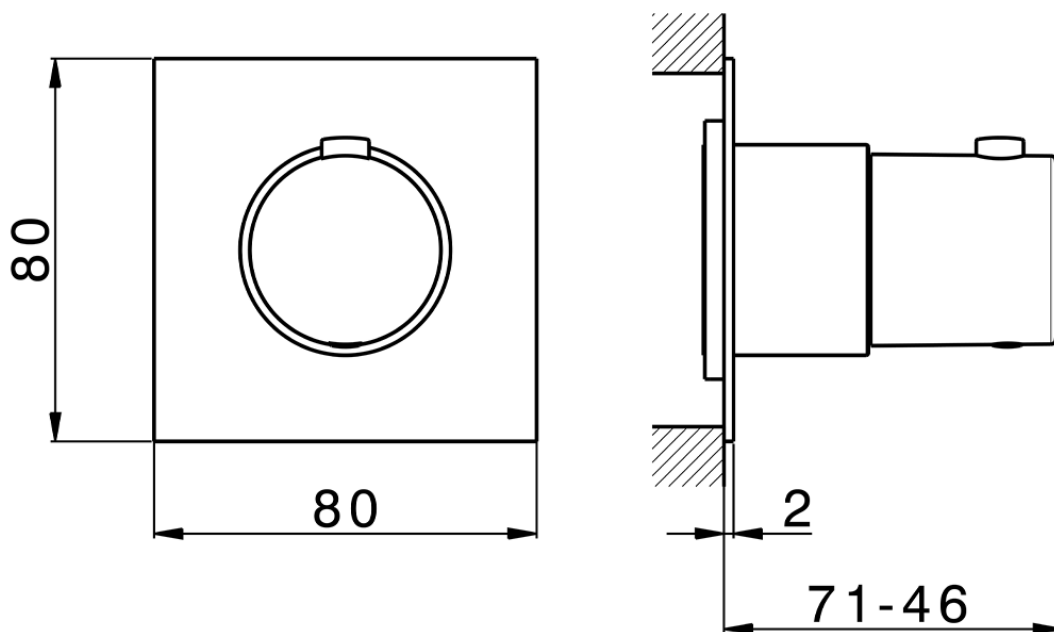

PS1G1030

<https://en.cisal.it/exposed-part-for-thermostatic-concealed-valve-pushshower-ps1g1030>

2026-05-19