

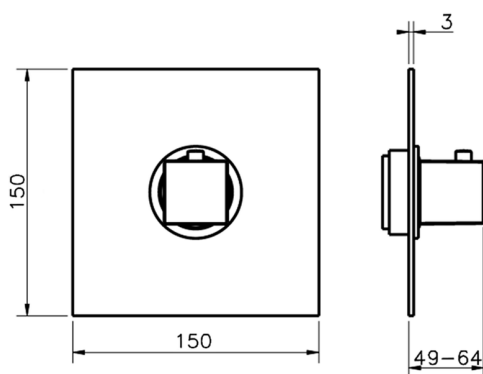





## Exposed part for concealed thermo shower valve ROADSTER ACCENT\_RA007200



MODEL **RA007200**

Exposed part for concealed thermo shower valve, without stop valve, without concealed part, for item ZA007220

### AVAILABLE FINISHINGS

-  **21** 21 Chrome
-  **2B** 2B Polished Nickel
-  **2F** 2F Brushed Nickel
-  **2Q** 2Q Black Titanium
-  **40** 40 Matt Black
-  **4Q** 4Q Matt White

### CHARACTERISTICS

Installation **Concealed**  
 Required concealed parts **ZA007220**



### Thermostatic

The Cisal thermostatic is your personal water manager, helping you to handle, control and save water and energy.



## 3/4" Concealed thermostatic valve CONCEALED\_ZA007220

MODEL **ZA007220**

3/4" Concealed thermostatic valve, without  
Stopvalve, without trim kit

AVAILABLE FINISHINGS

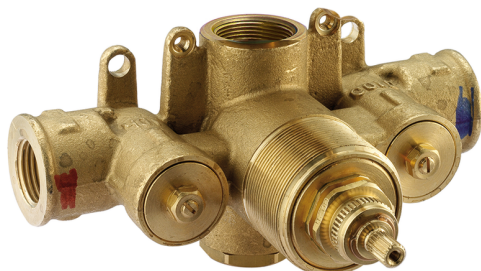
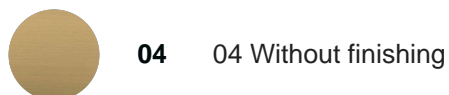

CHARACTERISTICS

Concealed **1**  
Cartridge Spare Parts **23.51A.HF**  
**HF Thermostatic Valve**

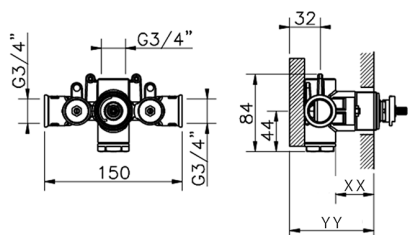

Piastra/Plate/Plaque/Platte/Placa

2-3mm: XX 25-40 YY 76-91

10mm: XX 16-31 YY 65-80



### Thermostatic

The Cisal thermostatic is your personal water manager, helping you to handle, control and save water and energy.



2024-12-22