

## Exposed part for individual Push&Shower PUSH&SHOWER\_PS1G6210

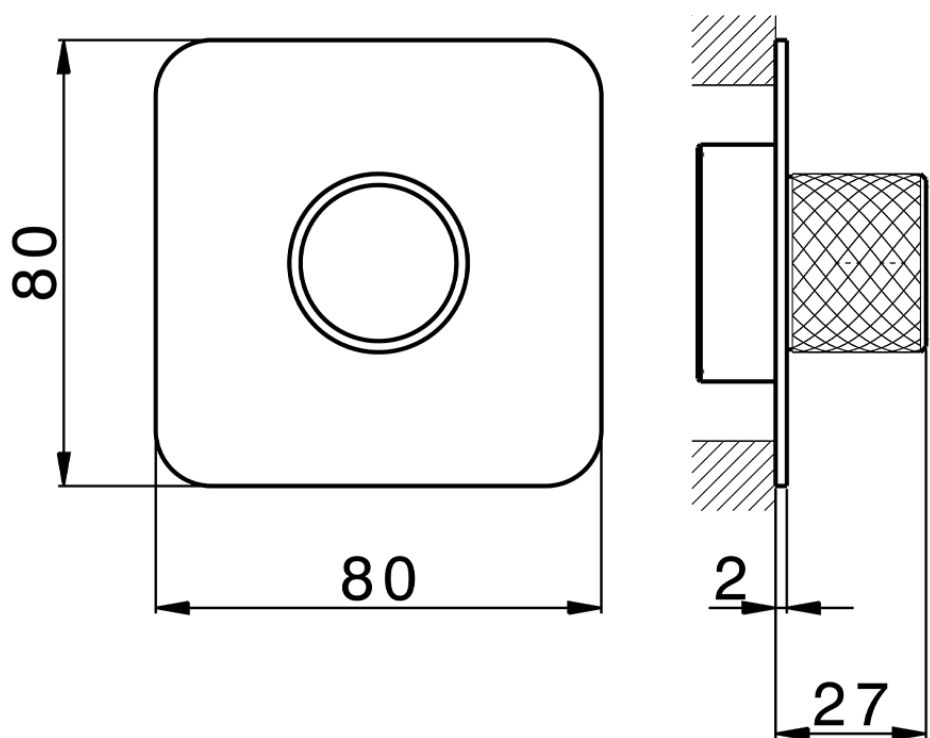

PS1G6210

<https://en.cisal.it/exposed-part-for-individual-pushshower-pushshower-ps1g6210>

2026-05-19