

Exposed part for con.thermo.shower valve, 3-outlet ROADSTER ACCENT_RA018200

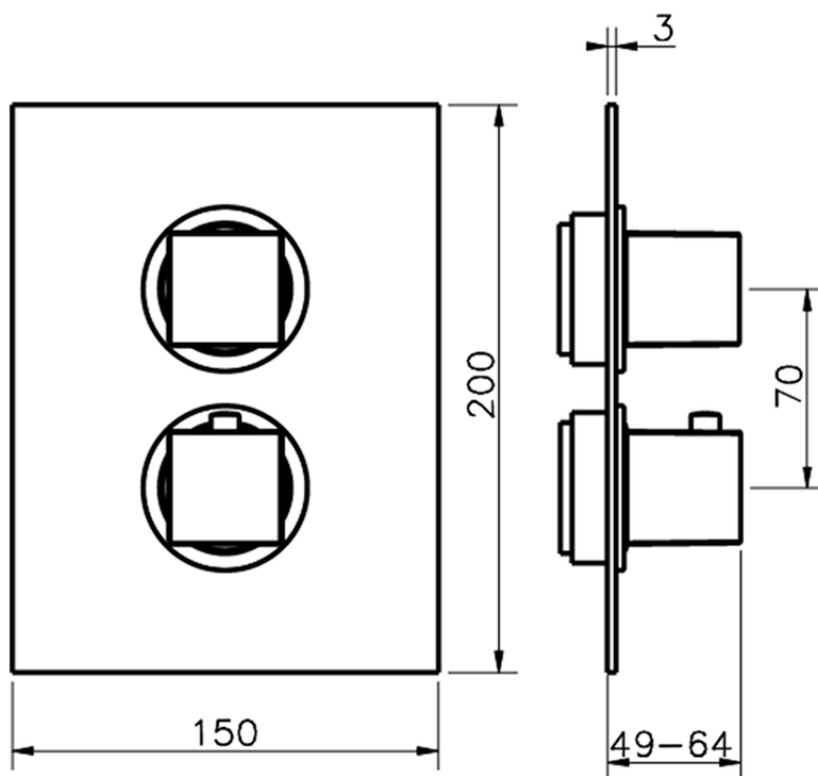

RA018200

<https://en.cisal.it/exposed-part-for-con-thermo-shower-valve-3-outlet-roadster-accent-ra018200>



Piastra/Plate/Plaque/Platte/Placa

2-3mm: XX 25-40 YY 76-91

10 mm: XX 16-31 YY 65-80

ZA018201

<https://en.cisal.it/concealed-thermostatic-shower-valve-3-outlets-concealed-za018201>

2026-06-14