





Exposed part for concealed washbasin mixer NUOVA LESS_LN013515

MODEL **LN013515**

Exposed part for concealed washbasin mixer, without concealed part, for items ZA033511

AVAILABLE FINISHINGS

-  **21** 21 Chrome
-  **2F** 2F Brushed Nickel
-  **40** 40 Matt Black
-  **4Q** 4Q Matt White

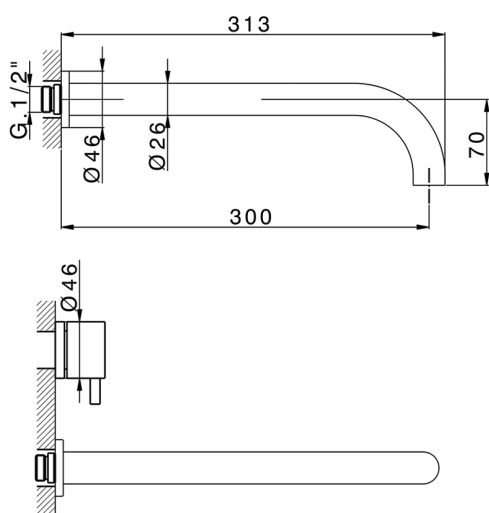

CHARACTERISTICS

Installation **Concealed**
 Required concealed parts **ZA033511**



Exposed part for concealed washbasin mixer NUOVA LESS_LN013515

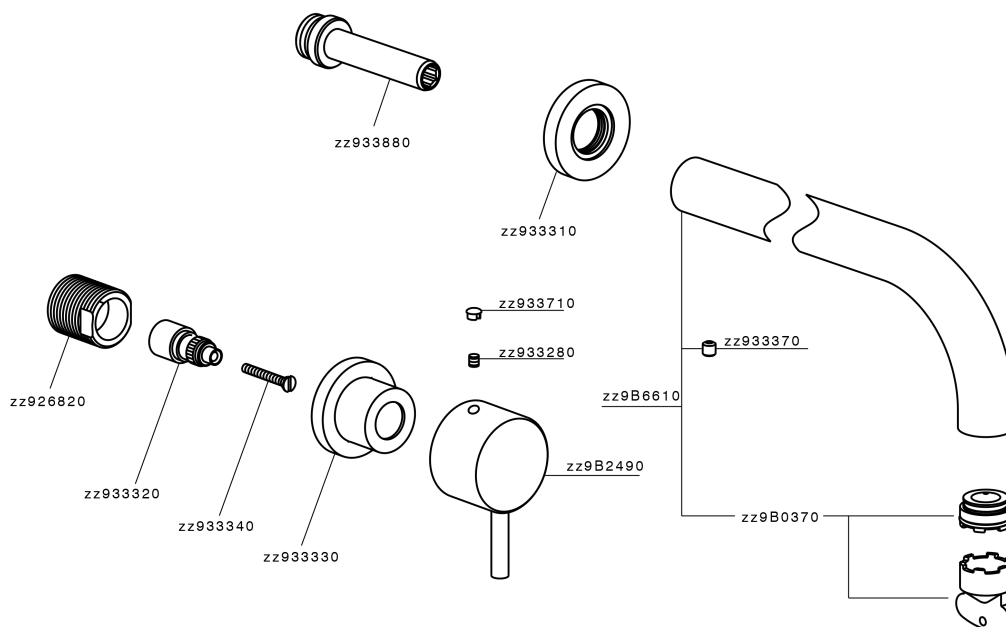

LN013515

<https://en.cisal.it/exposed-part-for-concealed-washbasin-mixer-nuova-less-ln013515>

Concealed washbasin mixer CONCEALED_ZA033511

MODEL **ZA033511**

Concealed washbasin mixer, right headvalve - left headvalve

AVAILABLE FINISHINGS

 **04** 04 Without finishing



CHARACTERISTICS

Concealed **1**

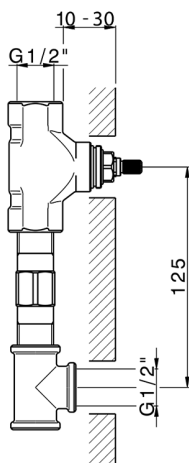

2024-12-22