

Deck mounted bath spout COMPONENTS_ZA002600

MODEL **ZA002600**

Deck mounted bath spout, with automatic diverter

AVAILABLE FINISHINGS



CHARACTERISTICS

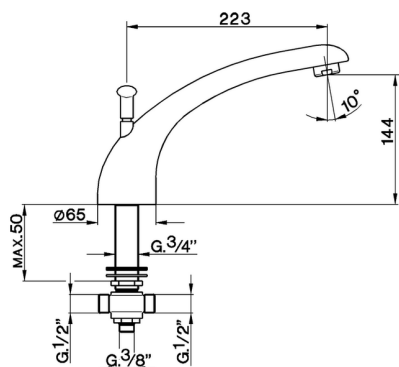

2026-04-26