

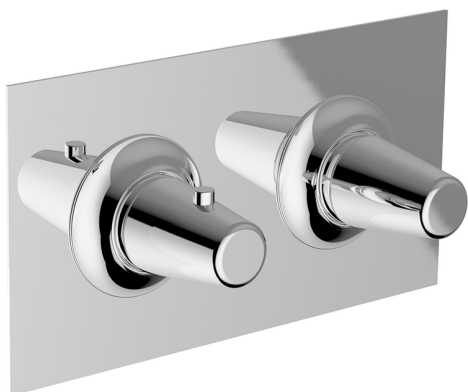



## Exposed part for con.thermo.shower mixer, 2-outlet VITA\_VI019140



MODEL **VI019140**

Exposed part for con.thermo.shower mixer, 2-outlet, with 2 outlet deviator, without concealed part, for item ZA019140

### AVAILABLE FINISHINGS

-  **21** 21 Chrome
-  **2Q** 2Q Black Titanium
-  **40** 40 Matt Black
-  **4Q** 4Q Matt White

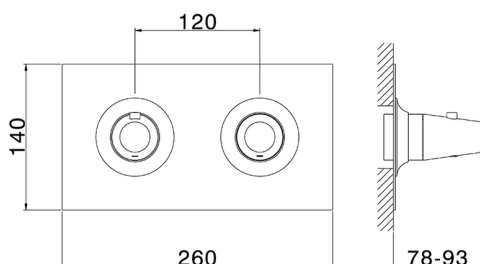

### CHARACTERISTICS

Installation **Concealed**  
 Required concealed parts **ZA019140**



### Thermostatic

The Cisal thermostatic is your personal water manager, helping you to handle, control and save water and energy.



## Exposed part for con.thermo.shower mixer, 2-outlet VITA\_VI019140

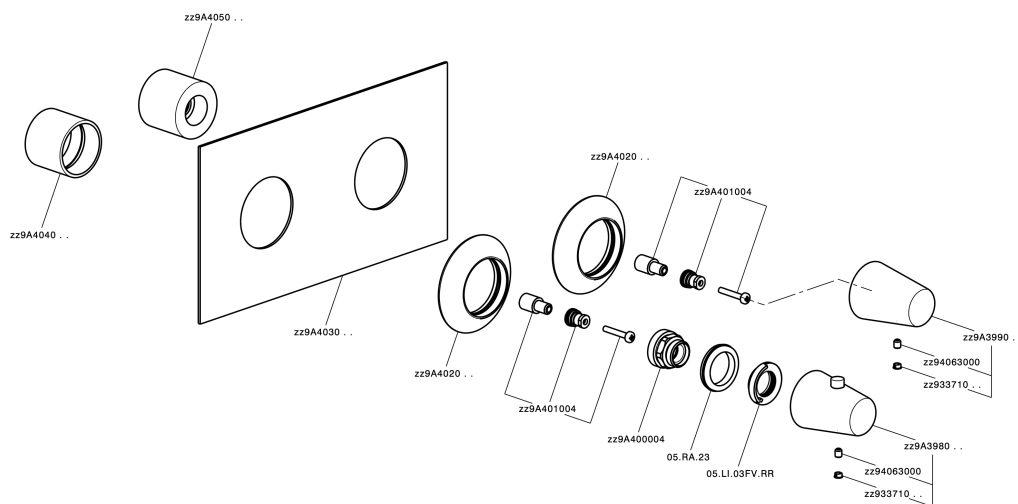

VI019140

<https://en.cisal.it/exposed-part-for-con-thermo-shower-mixer-2-outlet-vita-vi019140>

## Concealed thermostatic shower mixer, 2-outlets CONCEALED\_ZA019140

MODEL **ZA019140**

Concealed thermostatic shower mixer,  
2-outlets, without trim kit

AVAILABLE FINISHINGS



**04** 04 Without finishing



CHARACTERISTICS

Concealed **1**  
Cartridge Spare Parts **24.04A.PP**

**8x20 Plus P Thermostatic Valve**

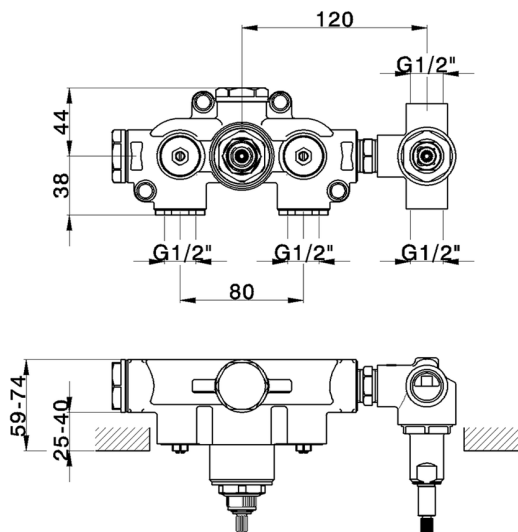

### Thermostatic

The Cisal thermostatic is your personal water manager, helping you to handle, control and save water and energy.



2026-06-05