

Shower mixer, full equipment GRACE_GS000460

MODEL **GS000460**

Shower mixer, full equipment, 60 cm slide rail kit with sliding bracket, 22,5 mm Brass One Spray handshower, 150 cm SUPREME smooth flexible hose

AVAILABLE FINISHINGS

-  **21** 21 Chrome
-  **2F** 2F Brushed Nickel
-  **2W** 2W Brushed Gold
-  **5H** 5H Dark Brass Brushed
-  **5L** 5L Brushed Black Titanium
-  **6T** 6T Chrome/Matt Black

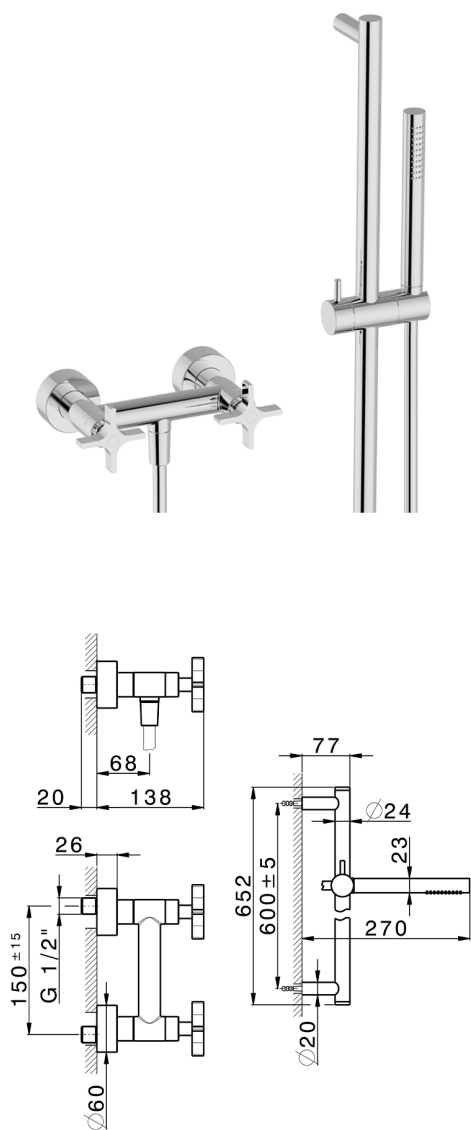

CHARACTERISTICS



2026-04-26