

**Cover Part for 2 Function Concealed Thermo Valve SMOOTH X32\_X300R200**

X300R200

<https://en.cisal.it/cover-part-for-2-function-concealed-thermo-valve-smooth-x32-x300r200>

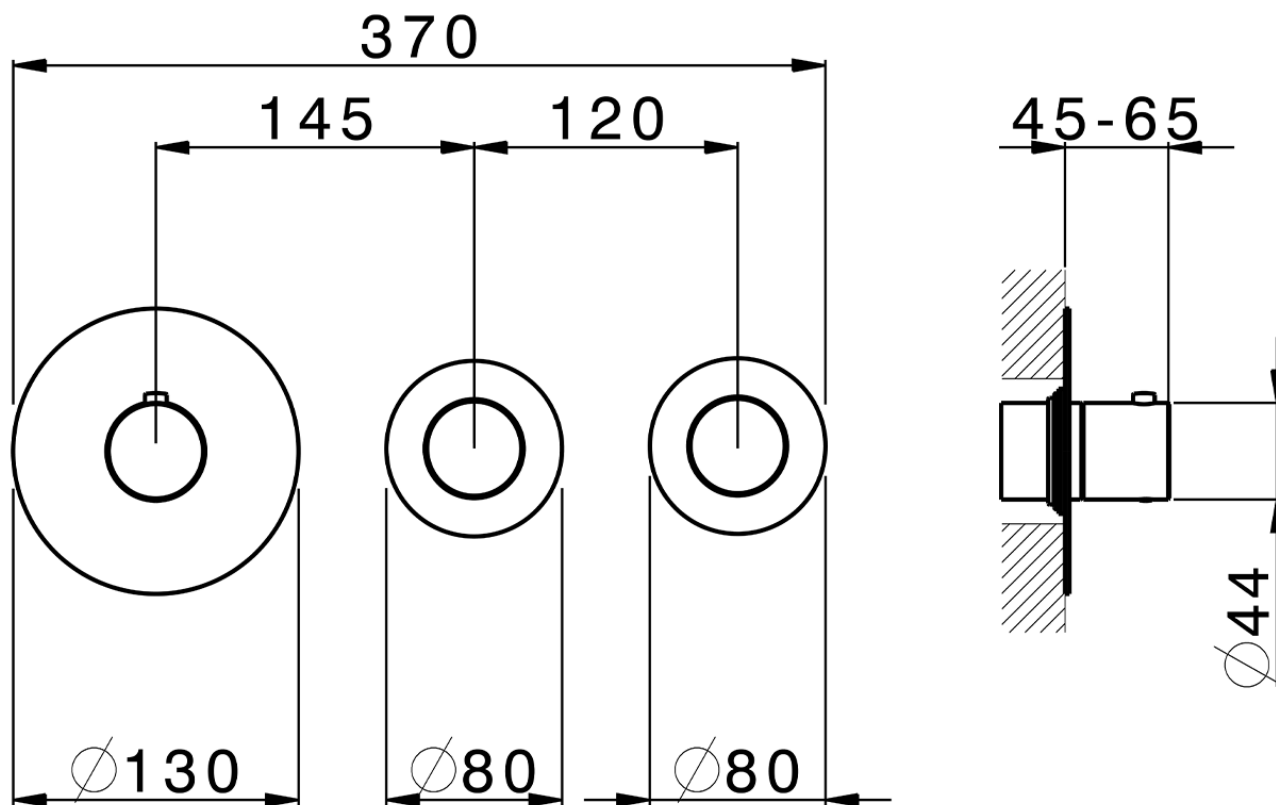
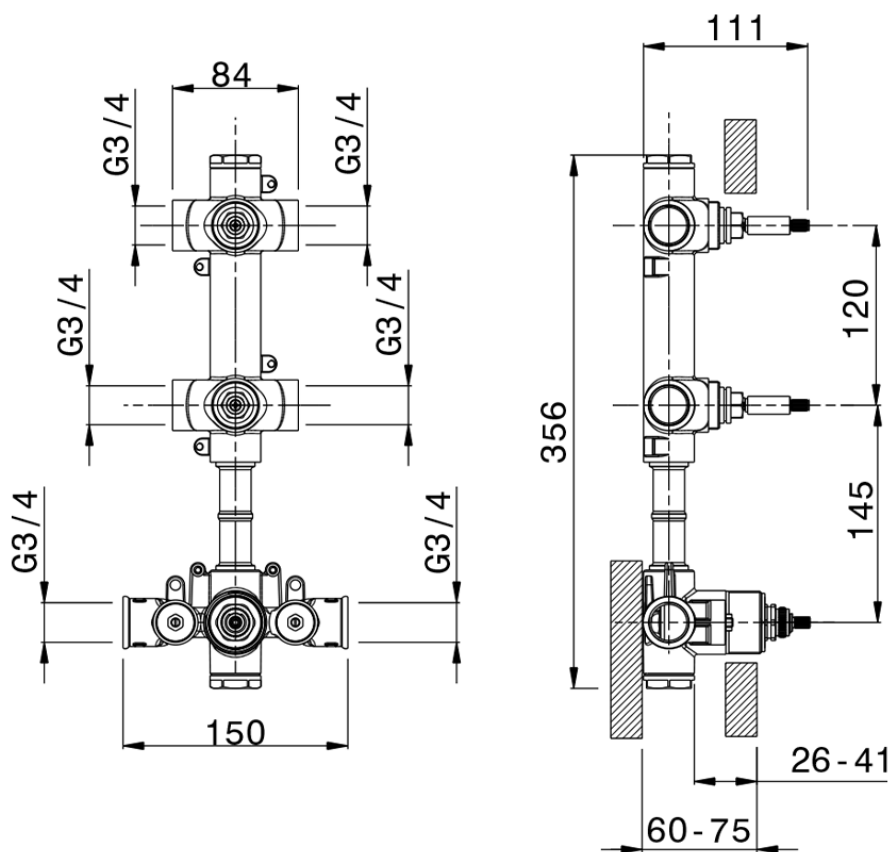

ZA00V200

<https://en.cisal.it/2-function-concealed-thermostatic-valve-concealed-za00v200>



ZA00R200

<https://en.cisal.it/2-function-concealed-thermostatic-valve-concealed-za00r200>

2026-06-14