





## Exposed part for Single Lever One Box Valve ONE BOX\_X10BM030

MODEL **X10BM030**

Exposed part for Single Lever One Box Valve, with 2-3 outlet diverter, Minimum depth of installation: 67 mm, without concealed part - Inox AISI 316L, for items ZA00B030-ZA00B031

### AVAILABLE FINISHINGS

-  **5H** 5H Dark Brass Brushed
-  **5L** 5L Brushed Black Titanium
-  **5N** 5N Brushed Rose Gold
-  **D1** D1 Brushed Inox

### CHARACTERISTICS

Cartridge Spare Parts **ZZ97179000**  
**35 mm Cartridge**  
 Installation **Concealed**  
 Required concealed parts **ZA00B031**  
**ZA00B030**

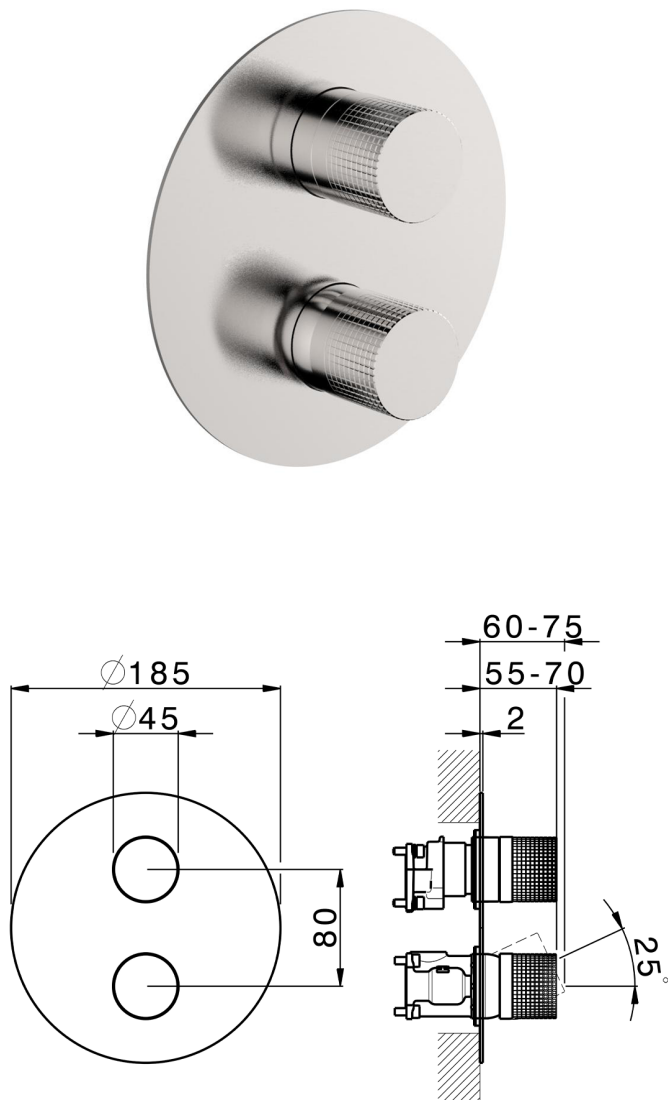

## Exposed part for Single Lever One Box Valve ONE BOX\_X10BM030

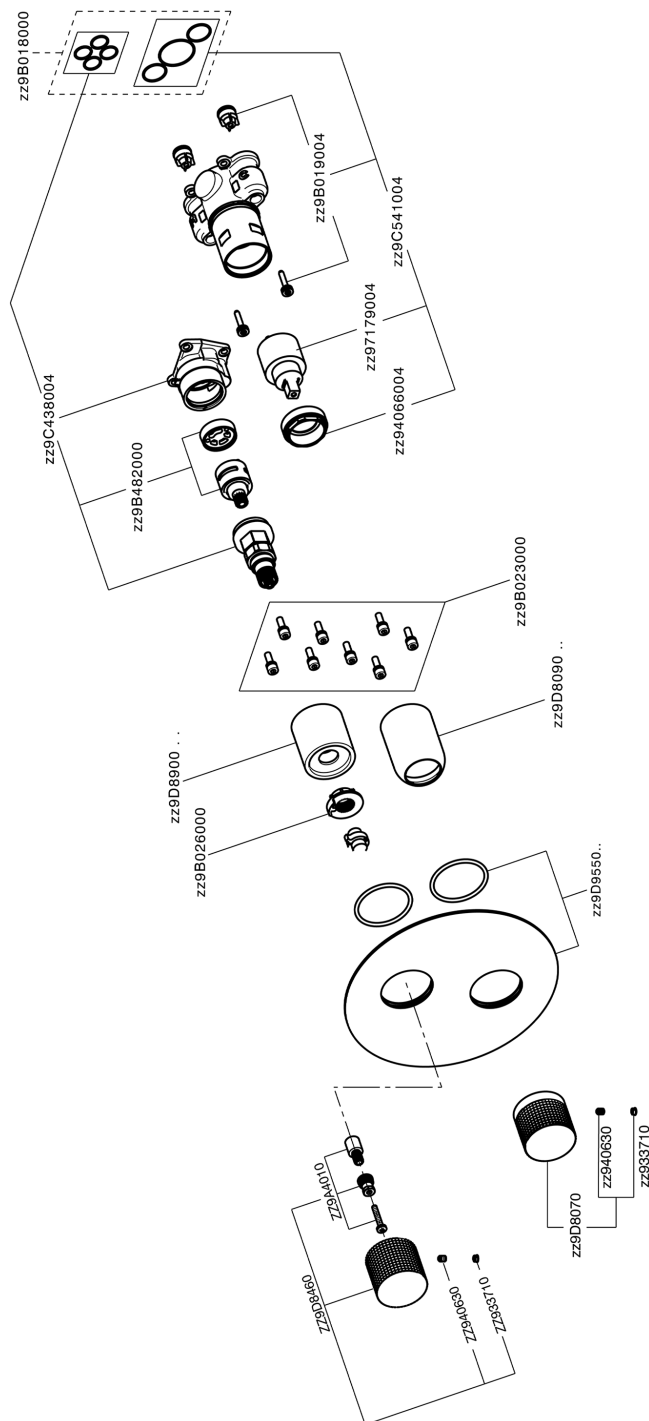

X10BM030

<https://en.cisal.it/exposed-part-for-single-lever-one-box-valve-one-box-x10bm030>

## One Box Universal Concealed Part ONE BOX\_ZA00B031

MODEL **ZA00B031**

One Box Universal Concealed Part, for 1, 2 or 3 outlet thermostatic or single lever, without trim kit, with noise reducers, with sealing gasket

AVAILABLE FINISHINGS

 **04** 04 Without finishing

CHARACTERISTICS

Concealed **1**



### Thermostatic

The Cisal thermostatic is your personal water manager, helping you to handle, control and save water and energy.



## One Box Universal Concealed Part ONE BOX\_ZA00B030

MODEL **ZA00B030**

One Box Universal Concealed Part, for 1, 2 or 3 outlet thermostatic or single lever, without trim kit, without noise reducers, with sealing gasket

AVAILABLE FINISHINGS

 **04** 04 Without finishing

CHARACTERISTICS

Concealed **1**



### Thermostatic

The Cisal thermostatic is your personal water manager, helping you to handle, control and save water and energy.



2024-12-22